



INSTALLATION, OPERATING AND MAINTENANCE MANUAL

ROCKER ARM SPOT WELDERS

PM/PP 19 – PM/PP 29 – PP 24 DIGITAL



INDEX

1. GENERAL INSTRUCTIONS

- 1.1 Manufacturer and welding machine identification data
- 1.2 General safety warnings
- 1.3 Prevention measures to be taken by the user
- 1.4 Technical data
- 1.5 Intended and non intended use
- 1.6 Description of the product and how it works
- 1.7 General overview

2. INSTALLATION INSTRUCTIONS

- 2.1 Environmental conditions
- 2.2 Energy requirement
- 2.3 Connection to the energy sources
- 2.4 Data on transporting, storage and assembly
- 2.5.1 Wiring diagrams
- 2.5.2 Wiring diagrams
- 2.5.3 Wiring diagrams
- 2.5.4 Wiring diagrams
- 2.5.5 Wiring diagrams
- 2.6 Pneumatic diagrams
- 2.7 Cooling circuit

3. INSTRUCTIONS FOR THE OPERATOR

- 3.1 Description of the functions
- 3.2 Guide to starting the welding machine for the first time
- 3.3 Getting ready to weld
- 3.4 Influence of the different welding parameters
- 3.5 Checking spot quality
- 3.6 Operating guide
- 3.7 Description of the welding control units
- 3.8.1 Troubleshooting
- 3.8.2 How to eliminate welding defects

4. MAINTENANCE INSTRUCTIONS

- 4.1 Maintenance information
- 4.2 Guide to maintenance
- 4.3 Spare parts
- 4.4 Technical assistance

1.	GENERAL INSTRUCTIONS
----	-----------------------------

1.1	MANUFACTURER AND WELDING MACHINE IDENTIFICATION DATA
-----	---

Manufacturer data

HELVI S.p.A.
Viale Galileo Galilei 123
36066 Sandrigo (VI) Italia

Tel. +39-0444-666999
Fax +39-0444-750070
E-mail: info@helvi.com

Welding machine data

Resistance type welding machine; see the data plate on the machine and the certificate of conformity attached to this manual for the model, serial number and year of construction.

Introduction

This manual contains the information needed to install, use and service your welding machine.
Follow the instructions to get the best out of your welding machine, in the most economical way and in complete safety.

1.2 GENERAL SAFETY WARNINGS







THE FAILURE TO OBSERVE THESE WARNINGS AND/OR ANY MODIFICATION OF OR TAMPERING WITH THE WELDING MACHINE WILL RELEASE P.E.I.-POINT FROM ANY LIABILITIES IN THE CASE OF ACCIDENTS TO PEOPLE OR DAMAGE TO THINGS AND/OR TO THE WELDING MACHINE ITSELF.

Before turning the welding machine on it is essential that the user knows how to carry out all the operations described in this manual.

The manual is an integral of the machine and must be kept until it is disposed of.

RESIDUAL RISKS

By residual risks we mean any hazard that could not be totally eliminated with the design or protection means and any potential hazard that is not evident.

	<p>There must not be excessive quantities of dust, acids, corrosive substances or gases etc., on the premises except those generated by the welding machine. We recommend keeping an extinguisher near the workstation.</p>
	<p>It must not be excessively humid on the premises. We recommend using an insulating platform. All maintenance jobs must be done on the machine only after having disconnected it from the electricity mains.</p>
	<p>Mind your hands when working; always keep them well away from the electrodes and moving parts when welding.</p>
	<p>The strong magnetic field that the welding machine generates during welding can be dangerous for people wearing pacemakers. Watches and electronic devices in general, if placed near the welding machine, can be damaged.</p>
	<p>Pay attention moving the welders: due to the high centre of gravity, the machine could roll over</p>
	<p>An incorrect adjustment of welding pressure, an erroneous setting of parameters or malfunctioning of the pneumatic system can all cause squirts of melted material during welding.</p>
	<p>The electrodes become very hot during welding. Do not touch them with your bare hands immediately after welding.</p>

1.3 PREVENTION MEASURES TO BE TAKEN BY THE USER

- We recommend wearing safety glasses.
- The user must observe the safety instructions given on the welding machine
- Personal protection gear must comply with and be certified by current standards
- Signs must be placed in the vicinity of the machine relative to the risks that call for personal protection gear.
- It is compulsory that the user observe the accident prevention laws in force in his country.
- Just one operator who has been specifically trained to use welding machines and welding equipment can use the welding machine.
- Install a suction unit if the material to be welded produces fumes.
- The operator must wear glasses to protect his eyes against squirts of melted material, a protective apron and leather gloves.
- The operator must avoid wearing metal objects (bracelets, watches etc.)
- Routine and extraordinary maintenance jobs must only be done on the machine after having disconnected the power sources (electricity, pneumatic power).
- **Make sure the machine is earthed effectively and protected by a suitable RCD**

1.4 TECHNICAL DATA

		PM PP	19 19	PP- DIGIT	24	PM PP	29 29
NOMINAL POWER 50% DUTY CYCLE	kVA		15		20		25
SHORT CIRCUIT SEC. CURRENT	kA		8.9		11.5		13.6
MAX SEC. WELDING CURRENT	kA		7.1		9.2		10.9
ELECTRODE FORCE (6 bar)	daN		200		200		200
CONTINUOUS SECONDARY CURRENT	KA		3.3		3.4		5
SECONDARY VOLTAGE	V		3.2		4.15		4.9
NOMINAL POWER SUPPLY SINGLE PHASE	V		400		400		400
NOMINAL SUPPLY FREQUENCY	Hz		50/60		50/60		50/60
DELAYED FUSES	A		25		45		63
AIR CONSUMPTION (ONLY FOR PP)	Mc/1000 spots		3.3		3.3		3.3
WATER CONSUMPTION	l/min		4		4		4
MAX AIR PRESSURE ALLOWED (ONLY FOR PP)	bar		6		6		6
A-WEIGHTED EMISSION SOUND PRESSURE LEVEL	dB		<70 (A)		<70 (A)		<70 (A)
THROAT GAP e	mm		220		220		220
MAX USEFUL DEPTH l (ADJUSTABLE)	mm		550		550		550
ARMS DIAMETER	mm		40		40		40
ELECTRODE HOLDER DIAMETER	mm		20		20		20
ELECTRODES OPENING	mm		6-50		6-50		6-50
DIMENSIONS LxWxH	mm		1020*300*1270		1020*300*1270		1020*300*1270
WEIGHT	kg		115		120		125

1.5 INTENDED AND NON INTENDED USE

The failure to observe the prescribed instructions constitutes a condition of improper use from a technical point of view and as regards the safety of people.

Intended use conditions

HELVI welding machines must only be used for welding metals keeping within the power limits given on the data plate.. Only one trained operator is allowed to use the machine, who has experience in handling welding equipment.

Non intended use conditions

HELVI welding machines cannot be used to exert pressure or deform materials. It is forbidden to weld materials that can generate toxic vapours or cause explosions due to heating.

1.6 DESCRIPTION OF THE PRODUCT AND HOW IT WORKS

HELVI spot welders belong to the family of resistance type welding machines.

By this we mean autogenous welding obtained by *pressure*, without using weld material, using the thermal effect of electricity flowing through the components to be welded (Joule effect) for heating.

The components to be welded are gripped between two electrodes with a dual purpose: to let electricity pass through and to exert enough force for welding.

The intensity of the current, the force on the electrodes and weld time are the most important parameters for welding. Force must be applied during the electrodes' squeeze time phases, weld time and holding time.

The welding cycle phases are managed by the welding control unit; the times set are given in mains periods (1/50th of a second if mains frequency is 50 Hz).

The main switch turns the welding machine on (item 3) which also has the function of an emergency stop switch.

Welding is started either by the electric pedal for PP (item 9) and mechanical pedal for PM (item 22).

The welding machine is equipped with safety thermostats to stop operation if it overheats.

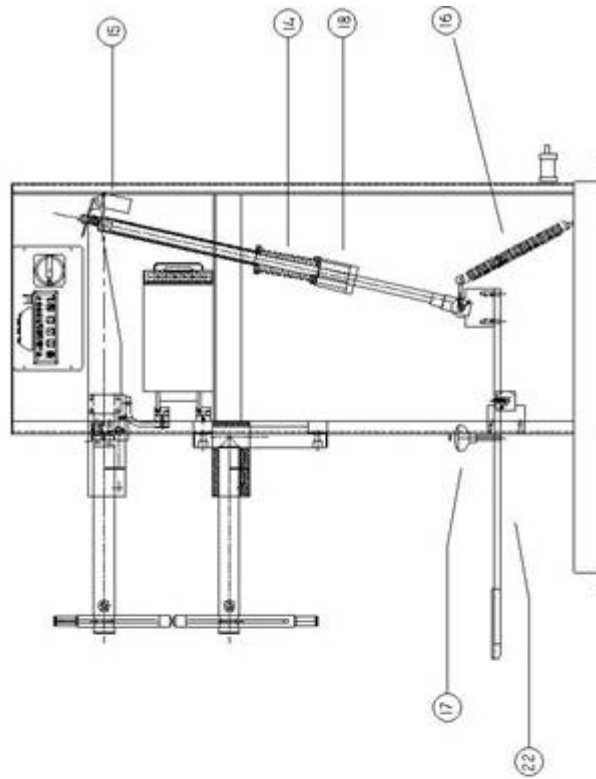
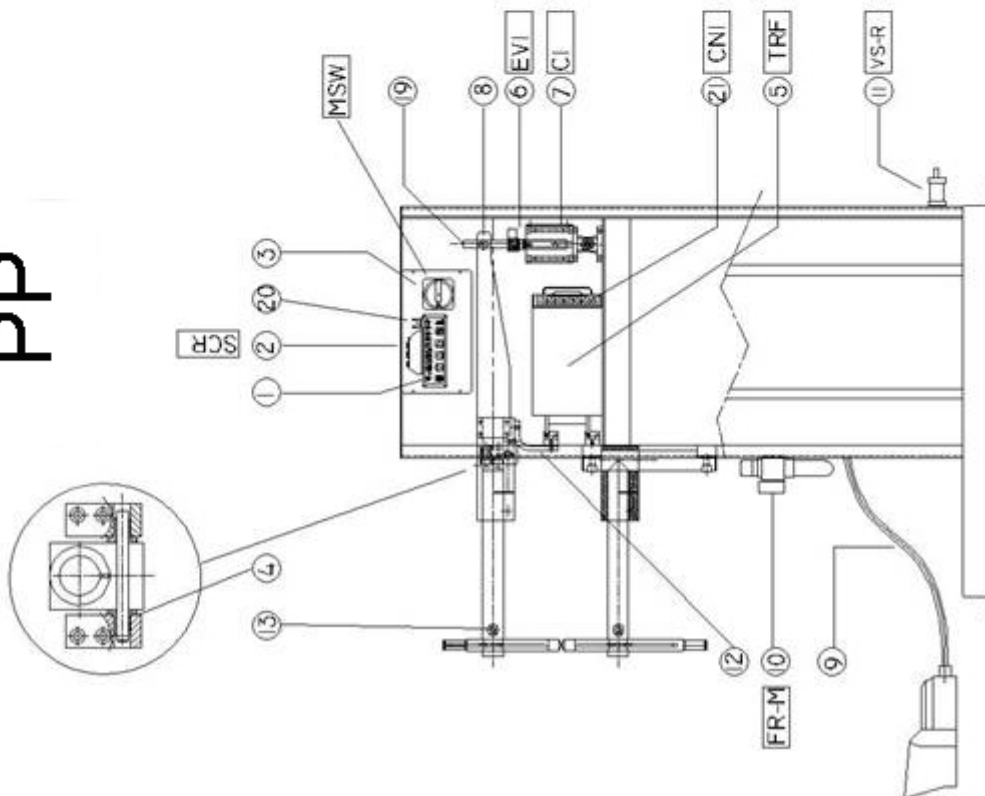
PM

PP

2.	INSTALLATION INSTRUCTIONS
-----------	----------------------------------

2.1	ENVIRONMENTAL CONDITIONS
------------	---------------------------------

Operating clearances

The machine must be positioned to ensure working and maintenance clearances and for any emergency situations that may arise. For this reason we recommend leaving a clearance of about 1 metre all around the machine.

Environmental characteristics

The place where the machine is going to be used must be suitably illuminated for both production and maintenance, free from dust, acids, corrosive substances or gases, with temperatures ranging between + 5°C and + 40°C.

Altitude must be less than 1000 metres.

Relative air humidity: 50% up to 40°C
 90% up to 20°C

Floor

The machine must be put on a flat surface that must also be able to withstand its weight. Machine must be fixed on to the floor by screws.

2.2	ENERGY REQUIREMENT
------------	---------------------------

Electricity

Nominal Power of Welder	Mains power (single-phase power) kVA
15	12
20	16
25	20

Pneumatic energy

Air consumption	See technical data
Minimum circuit pressure	6.5 bar 650 KPa

2.3 CONNECTION TO THE ENERGY SOURCES

Qualified personnel who can also certify their work must install the machine.

THE INSTALLER IS RESPONSIBLE FOR A CORRECT INSTALLATION AND, IN PARTICULAR, FOR THE CHOICE OF DEVICES TO PROTECT AGAINST SHORT CIRCUITING, OVERLOADS, LEAKAGE CURRENTS IN THE CASE OF A FAILURE AND OF THE WIRES USED TO CONNECT TO THE MAINS WHICH MUST COMPLY WITH CURRENT LAWS AND STANDARDS.

THE INSTALLER MUST ALSO CHECK THAT THE EARTHING SYSTEM, TO WHICH THE WELDING MACHINE IS CONNECTED, IS EFFECTIVE.

Electrical connection

Dimensioning of line fuses and the cross section of the supply cables. With a mains voltage of $V_1=400V$ and a mains frequency of $f=50Hz$.

Nominal power of welder	Normal current delayed fuses (A)	Supply cable cross section up to 20 metres (mm ²)
15	25	6
20	25	6
25	45	10

- Check machine plate data before connecting it (voltage rating, nominal frequency and number of phases).
- Connect the welding machine to an RCD with a minimum current dispersion of 30 mA.

The welding machine must be protected with either delayed line fuses or a circuit breaker with the values given in the above table.

Pneumatic connection (only for PP model)

Connect the air pipe, with an inside diameter of 7mm, to the inlet coupling.

Connection to the cooling circuit

- Install a cooling system that has the pressure characteristics given in the table
- Connect the water supply pipe to the machine's input connection
- Connect the water drain pipe to the machine's output connection
- Install a water conditioner if necessary

Inside pipe diameter	7 mm
Minimum coolant pressure	2.5 bar
Maximum coolant pressure	4 bar
Minimum rate of flow	4 Lt/min
Maximum coolant temperature	30° C

2.4 DATA ON TRANSPORTING, STORAGE AND ASSEMBLY

Shipping

Make sure that the means used to transport the welding machine is strong enough to withstand its weight.

Pay attention to the air connections and projecting parts to avoid any damage being done.

The weights of the different models are given in the technical data.

Unpacking - Assembly

- Remove the packaging from the welding machine with care, checking that all the accessories are inside and that nothing has been damaged during shipping.

-

THE PEOPLE IN CHARGE OF LIFTING AND POSITIONING THE MACHINE MUST BE SUITABLY QUALIFIED.

2.5.1 WIRING DIAGRAMS - MODELS PP 19 / PP 29

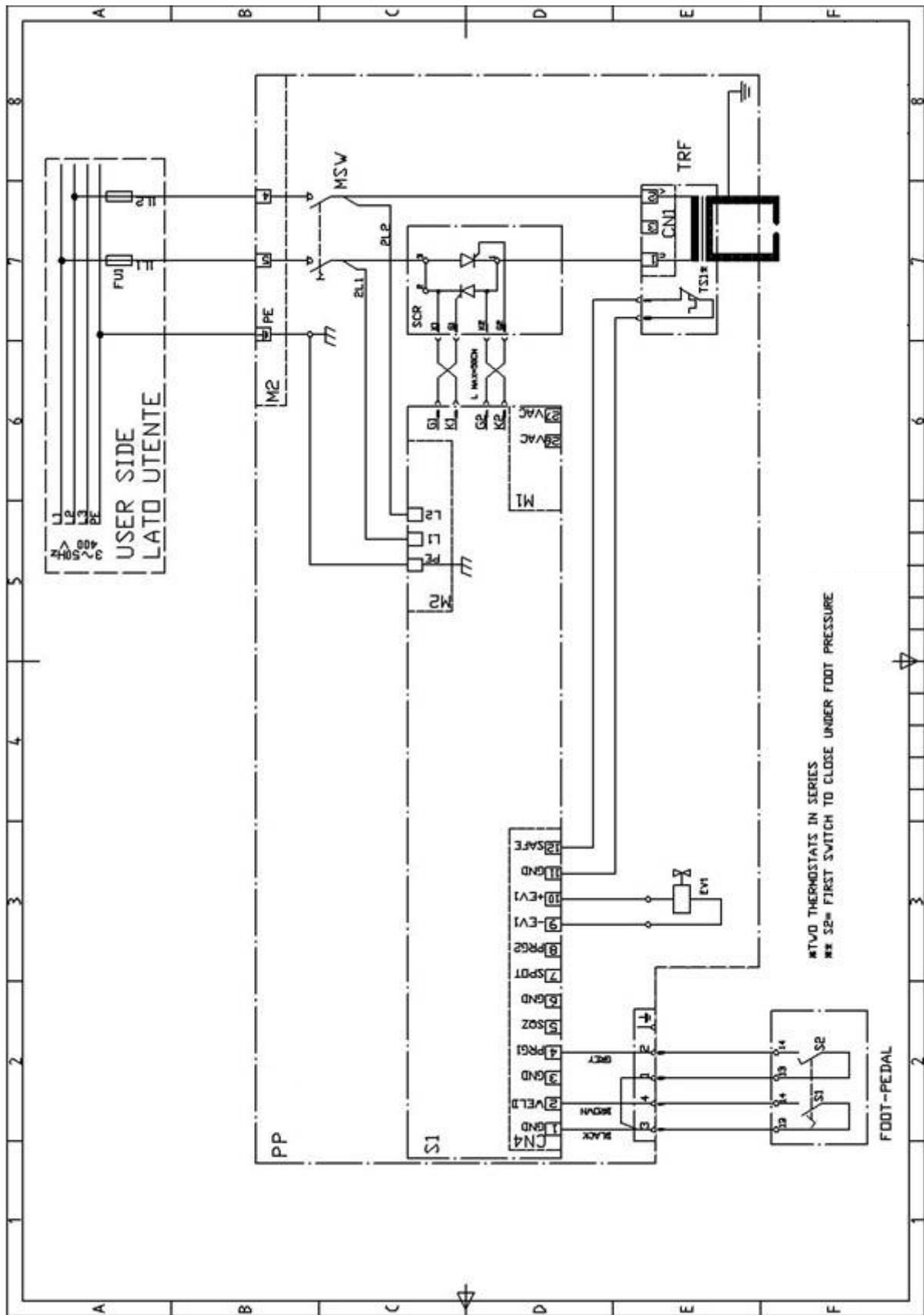

2.5.2 WIRING DIAGRAMS – MODELS PM 19 / PM 29

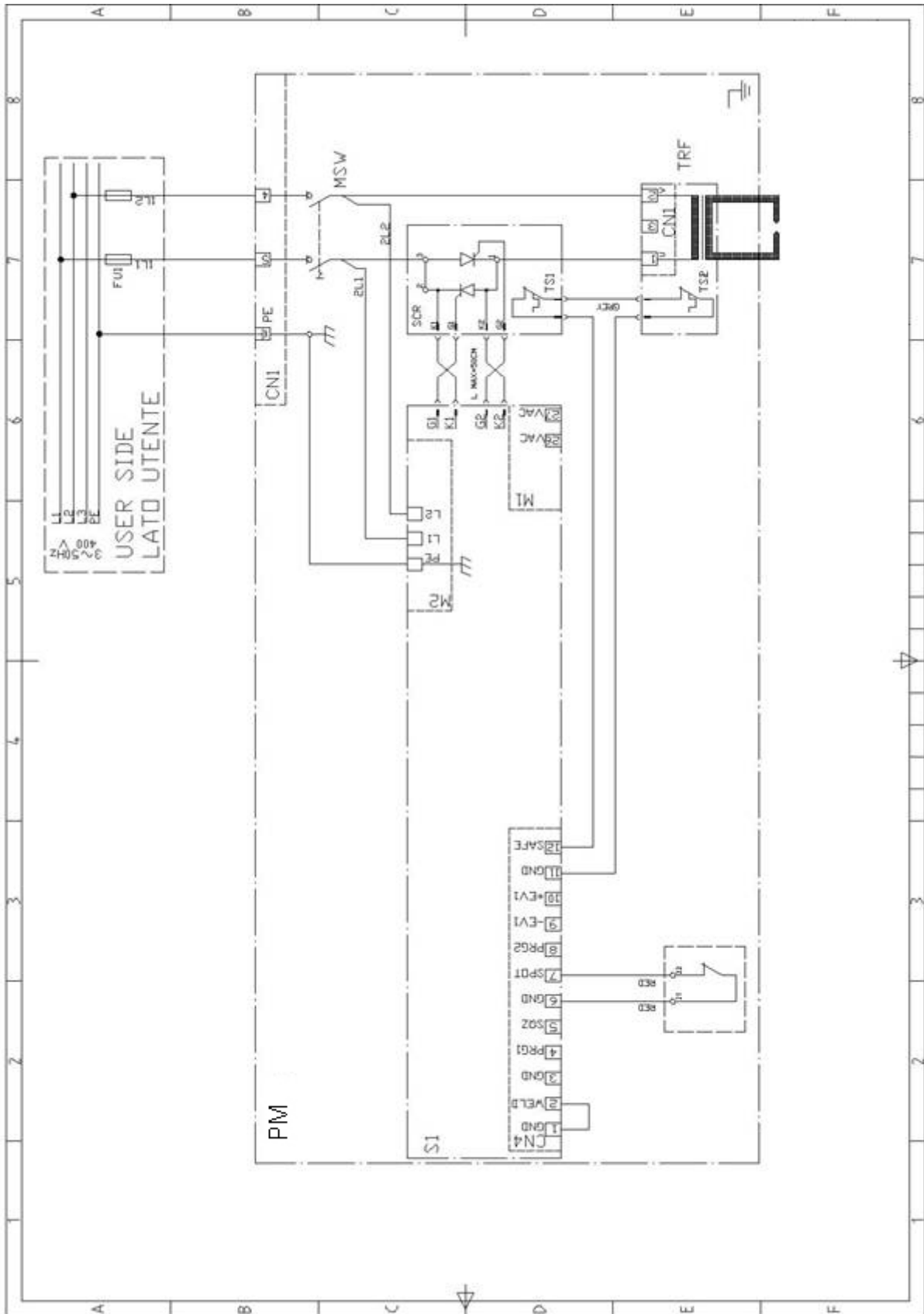

2.5.3 WIRING DIAGRAMS -- MODEL PP 24 DIGIT

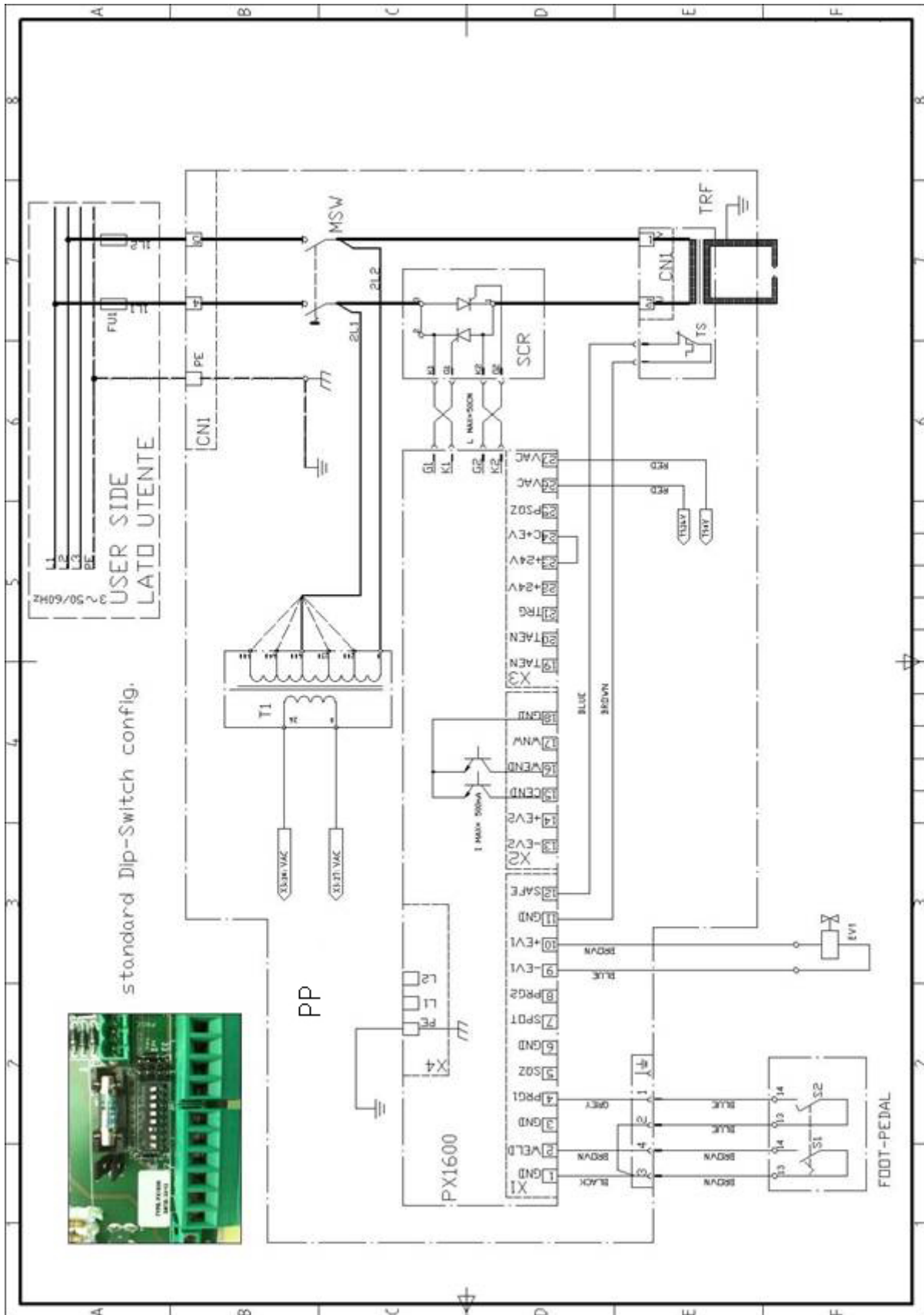

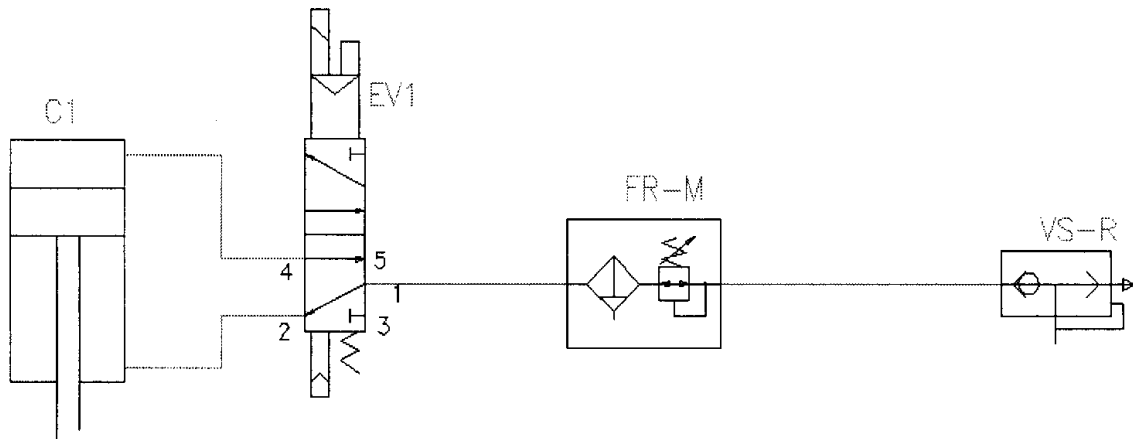

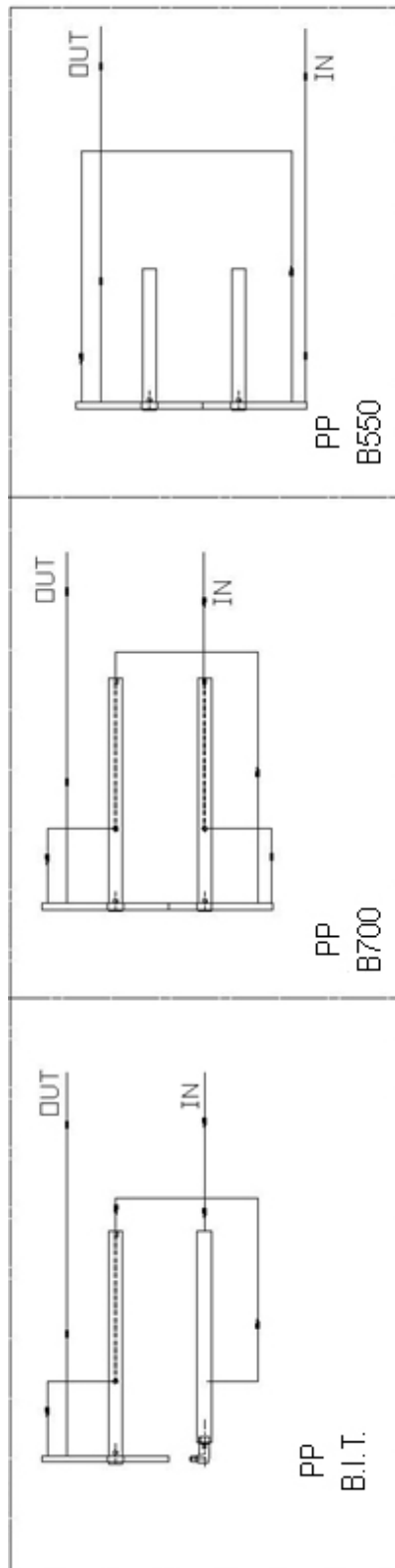
2.7 COOLING CIRCUIT

3. INSTRUCTIONS FOR THE OPERATOR

3.1 DESCRIPTION OF THE FUNCTIONS

To weld, the operator has to press the pedal.

When the welding control unit receives consent to start the cycle it performs the welding sequence according to the parameters set on it.

The sequence can be interrupted at any time by releasing the pedal.

If the pedal is released during weld time, the spot might not be strong enough.

3.2 GUIDE TO STARTING THE WELDING MACHINE FOR THE FIRST TIME

- a) check there is compressed air (for PP) and water cooling
- b) adjust the electrodes gap so that in welding position the arms will be parallel (for safety reason, the gap between electrodes should not exceed 6 mm)
- c) power on via the main switch
- d) set the required electrode force by means of the pressure adjuster (only on PP model)
- e) set welding parameters on the control unit (see next paragraph)

3.3 GETTING READY TO WELD

WELDING CYCLE

The welding cycle consists of three basic times:

Squeeze time: it is the interval of time between the start of the cycle and the moment the electrodes, under the force exerted on them, come into contact with the piece to be welded.

Weld time: this is the time during which the welding current passes through the electrode contact area.

Holding time: this is the time during which the force of the electrodes is maintained after weld time has finished.

The welding cycle can be divided in different times; for a more detailed explanation of this please read the paragraph relative to the welding control units.

3.4 INFLUENCE OF THE VARIOUS PARAMETERS ON THE WELDING RESULT

Force on the electrodes

The greater the force is on the electrodes, the weaker contact resistance will be between the electrodes and the sheets and the **less risk** there will be of **melted material being squirted**.

However, the force on the electrodes is limited by the welding machine's capacity. The greater the force is on the electrodes, the greater the current value will be to achieve welding.

Weld time

Welding can be achieved with different weld times:

Short weld time: (less than 10 periods)	it effects a small area of material being heated but the welding machine's performance is superior.
Long weld time: (20-99 periods)	it leaves a heavy electrode mark on the sheets and utilises the machine to the utmost
Medium weld time: (10÷20 periods)	a good compromise between the two extremes

Current

Welding current influences the strength of the spot as does weld time but the influence is much stronger.

This means that current is the variable factor and must be adjusted with maximum attention.

To find the optimum welding current you have make several attempts on some sample pieces, starting from a low value (10) and gradually increasing up to a satisfactory value (max. 99).

3.5 CHECKING SPOT QUALITY

There are different ways to check the quality of a welding spot.

The best way, for the strength test, is the separation test of the welded parts.

This test entails gripping the welded sample pieces in a clamp and opening them with a scalpel. Strength is good if, after the sheets have been separated, there is a hole on one sheet and the melted core on the other sheet.

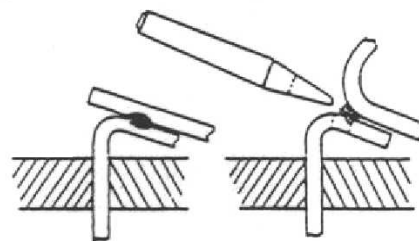
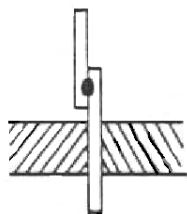
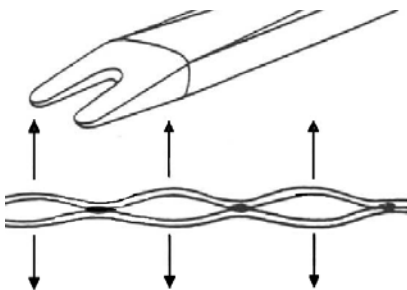

3.6 GUIDE TO STARTING

Prior to welding:

- Turn the welding machine on with the main switch (3) and check that the "set value" display turns on and that all the signalling lights are tested.
- Check on the gauge for compressed air (for PP model)
- Check that the set welding parameters are ideal for the piece you are welding and for electrode aperture (squeeze time).
- **Wear individual protection gear (gloves, glasses, aprons, etc.).**

Starting:

- Press the pedal to bring the electrodes to the point to be welded.
- Once squeeze time has elapsed, current will start passing between the sheets, determining the welding spot.

Stopping the cycle and emergency stopping:

- The cycle can be stopped at any time, when you take your foot off the pedal.
- To stop in an emergency, turn the main switch off and discharge the pneumatic circuit through the dump valve VS-R (item 11).

3.7 DESCRIPTION OF THE WELDING CONTROL UNIT

S1

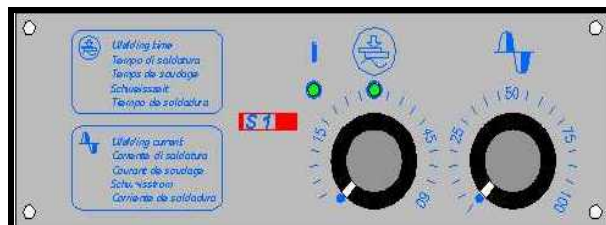



DESCRIPTION OF THE SYNOPTIC PANEL

The synoptic panel is divided in two parts. The top shows the graphical symbols of the available functions as well as the two LEDs signalling the power on and the welding time. The bottom includes two potentiometer for time and power adjustment.

DESCRIPTION OF THE FUNCTIONS

S1 is a timer that controls the welding cycle . A mains period is the timer's unit of time, corresponding to 1/50th of a second (50Hz). If, for instance, a welding time of 50 periods is set, time will be equal to 1 second.

	Weld time (0-60 periods): time during which the pieces to be welded have welding current passing through them.
	Power adjustment (0-100%): The value of the welding current is determined as a percentage of power.

OPERATING INSTRUCTIONS

When the welding machine is turned on the welding control turns on all the power on indicator light **I**.
 Simply press START for the welding machine to start the work cycle.
 During welding S1 displays the welding time of the cycle by turning the function LED on.

DESCRIPTION OF CONTROL CONNECTIONS CN4

No.	name	Description
4	PRG1 (in)	Start cycle
7	SPOT (in)	Start cycle without solenoid valve EV1 (active when low)
2	WELD (in)	Welding time enable (active when low)
12	SAFE (in)	Safety input: if open, cycle is not possible and both green LEDs flashing
5	SOZ (in)	When active, change status of output EV1
1-3-6-11	GND	∅ volt, common line for all the inputs
9-10	-EV1+EV1 (out)	EV1 supply (welding stroke) 24V / 7W

DESCRIPTION OF CONTROL CONNECTIONS M2

L1		Supply phase L1-400V 50/60 Hz
L2		Supply phase L2-400V 50/60 Hz
PE		Protection earth connection

DESCRIPTION OF CONTROL CONNECTIONS M1

1-2	Vac IN	Connections to supply control (24V ac) from external source: jumpers on CN3 must be removed
-----	-----------	--

DESCRIPTION OF JUMPERS ON CN3

	CLOSED	OPEN
CN3	Internal supply transformer enabled (parallel jumpers)	Internal supply transformer disabled (parallel jumpers)

PX1600 welding control

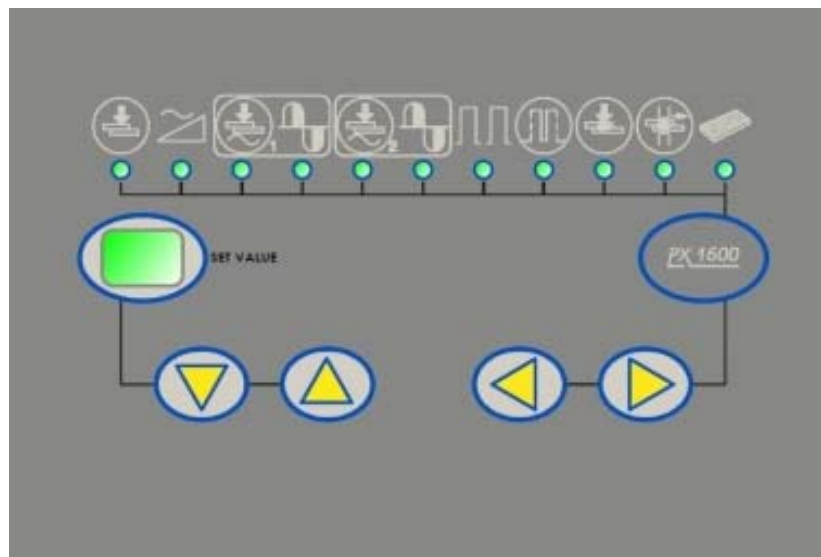











DESCRIPTION OF THE SYNOPTIC PANEL

The synoptic panel is divided in two parts. The top shows the graphical symbols of the functions available as well as the LEDs signalling the function selected. The bottom part has the four arrow keys for programming and a two-digit display that shows the value of the function selected.

DESCRIPTION OF THE FUNCTIONS

PX1600 is a timer that controls the welding cycle . A mains period is the timer's unit of time, corresponding to 1/50th of a second (50Hz). If, for instance, a squeeze time of 50 periods is set, time will be equal to 1 second.

	<p>Squeeze time (0-99 periods): it is the time needed by the welding machine's electrodes to come into contact with the piece to be welded and to exert the welding pressure Melted material will squirt if this time is too short.</p>
	<p>Current risetime (0-20 periods): Weld time with growing current increase. If this value is not zero, welding current will gradually reach the value required during risetime. This technique is used when welding extra thick sheets that are not well matched together, or for welding steel.</p>
	<p>Adjustment 1-2: Welding time and current, together with the force on the electrodes, are the most important parameters to make a spot weld. If the thickness of the pieces to be welded differ then (at least) the welding current has to be modified, leaving all the other parameters as they are. This is why PX1600 has two times and two different currents. Adjustment 1 or Adjustment 2 are selected automatically by the welding control if an additional foot pedal is fitted. If not, only Adjustment 1 is selected.</p>
	<p>Weld time (0-99 periods): time during which the pieces to be welded have welding current passing through them.</p>
	<p>Power adjustment (0-99%): The value of the welding current is determined as a percentage of power.</p>
	<p>Number of pulses (1-20): weld time is repeated without opening the electrodes, according to the value set. Attention: this function cannot be used if weld time is longer than 20 periods</p>
	<p>Cold time (0-99 periods): pause time between welding pulses.</p>
	<p>Holding time (0-99 periods): time during wich the electrodes stay closed after weld time</p>
	<p>Pause time (0-99 periods): if this time is 0, the welding machine will carry out a single welding cycle even if the START signal persist. If this time is not 0 the welding cycle will be repeated automatically. In such a case, pause time determines the interval between one cycle and another.</p>
	<p>Energy function (0-1): By setting value 1 the "energy compensation" function is enabled to facilitate the welding of dirty or oxidised sheets. This function is disabled if 0 is set.</p>

PROGRAMMING

When the control is not carrying out a welding cycle it can be used to programme or modify welding parameters.

Simply press the  key to select the parameters of the welding cycle wanted.

The illuminated green LED under the graphical symbol highlights the function selected.

The SET VALUE display shows the value of the function selected. With keys  the value contained in the SET VALUE is either increased or decreased.

OPERATING INSTRUCTIONS

When the welding machine is turned on the welding control carries out a test on all the indicator lights. The SET VALUE display shows the software version installed.

Subsequent to self-testing, control returns as it was prior to turning off; simply press START for the welding machine to start the work

cycle.

During welding PX1600 displays all the phases of the cycle by turning the function LEDs on in sequence.

SELECTING THE WELDING PROGRAMME

PX1600 can carry out nine different welding programmes.

To select the one you want, press the key  several times until the display starts flashing.

PX1600 will now display the active programme.

If you wish to recall a different programme use the keys  selecting a value between 1 and 9.

ERROR MESSAGE

<i>CODE</i>	<i>CAUSE</i>	<i>REMEDY</i>
" 00 "	<ul style="list-style-type: none"> The thermostats have tripped 	<ul style="list-style-type: none"> Welding time is too long Water cooling is not OK

DESCRIPTION OF CONTROL CONNECTIONS

No.	name	Description
4	PRG1 (in)	Start cycle with time-current 1 (active when low)
8	PRG2 (in)	Start cycle with time-current 2 (active when low)
7	SPOT (in)	Start cycle with time-current 2 without solenoid valve EV1 (active when low)
2	WELD (in)	Welding time enable (active when low)
17	WNW (in)	Excludes the current from the welding cycle (active when low)
12	SAFE (in)	Safety input: if high, cycle is not possible and display "00" flashing
5	SOZ (in)	When active, change status of output EV1
25	PSQZ (in)	When active, change status of output EV2 (if SW 1.1 = ON) If SW1.1 = OFF EV2 is "on" if the input PSQZ is active
16	WEND (out)	End of welding time: become low after the welding time; it will be active till the start signal (PRG1 or PRG2) are active (open collector 500mA max)
15	CEND (out)	End cycle: become low after the welding time; it will be active till the start signal (PRG1 or PRG2) are active (open connectors 500mA max)
1-3-6-11-18	GND	∅ volt, common line for all the inputs
22-23	+24V	Supply voltage (24V dc 500mA max)
24	C+EV1	+ EV1 (connect to +24V with a safety switch or a jumper)
13-14	-EV2+EV2 (out)	EV2 supply (extra stroke cylinder) 24V / 7W
9-10	-EV1+EV1 (out)	EV1 supply (welding stroke) 24V / 7W
19-20	TAEN-TAEN (in)	Input signal for welding current sensor
26-27	Vac IN	Connections to supply control (18-24V ac) from external source
21	TRG	Firing signal for external SCR firing module
L1		Do not connect
L2		Do not connect
PE		Protection earth connection

DESCRIPTION OF DIP-SWITCHES FUNCTION
SOFTWARE VERSION 2.1

		OFF	ON
SW1.1	Out ev2	Monostable	Bistable
SW1.2	Energy compensation	Disabled	Enabled
SW1.3	Cos fi adjustment	Minimum	Maximum
SW1.4	Time unit	1 cycle	½ cycle
SW1.5	Pause time	Enabled	Disabled
SW1.6	Out ev1	Free	EV1=on if EV2=on
SW1.7	First half cycle delay	3.5 msec.	4 msec.
SW1.8	Seam welding operation	Not	Yes

3.8.1 TROUBLESHOOTING AND A GUIDE TO ELIMINATING PROBLEMS IN THE WELDING CYCLE

PROBLEM	CAUSE	REMEDY
The control unit does not turn when the main switch has been turned on.	<ul style="list-style-type: none"> No electricity Line fuses have blown Fuses on the control unit have blown 	<ul style="list-style-type: none"> Check mains voltage and soundness of the fuses
The control unit turns on but when the push button is pressed the welding cycle fails to start.	<ul style="list-style-type: none"> Mains voltage is too low 	<ul style="list-style-type: none"> Check mains voltage and compare it with the machine's rating plate data.
The control unit turns on and the SET VALUE display flashes "00"	<ul style="list-style-type: none"> The thermostats have tripped 	<ul style="list-style-type: none"> Welding programming time is too long Water cooling is not OK
Squirts of material when the electrodes come into contact	<ul style="list-style-type: none"> Squeeze time is too short Electrodes' pressure is too low SCR has short circuited 	<ul style="list-style-type: none"> Increase squeeze time Increase force on the electrodes Change the SCR
While you are welding there is a loud noise coming from the welding transformer and the line fuses blow	<ul style="list-style-type: none"> SCR has failed 	<ul style="list-style-type: none"> Change the SCR Change the control card

3.8.2 HOW TO ELIMINATE WELDING DEFECTS

DEFECT	CAUSE	REMEDY
Squirts of melted material	<ul style="list-style-type: none"> Squeeze time is too short Force on the electrodes is too weak Welding current is too high Insufficient contact of the electrodes 	<ul style="list-style-type: none"> Increase squeeze time Increase force on the electrodes Reduce welding current
The mark on the welded pieces is too pronounced	<ul style="list-style-type: none"> Electrodes' diameter is insufficient Force on the electrodes is too strong Welding current is too high Welding time too long 	<ul style="list-style-type: none"> Change the electrodes with ones of a suitable diameter Reduce pressure Reduce welding power (time and current)
Spot strength is not good enough	<ul style="list-style-type: none"> Weld time is too short Current is too weak Electrodes' diameter is too big Excessive force on the electrodes Secondary circuit contacts are dirty 	<ul style="list-style-type: none"> Increase weld time Increase welding current Reduce electrode diameter Reduce electrode force Clean the secondary circuit
Deformed electrodes	<ul style="list-style-type: none"> Weld time is too long Excessive force on the electrodes Excessive current Insufficient contact area The electrodes' copper alloy is too weak 	
Craters in the welding core	<ul style="list-style-type: none"> Holding time is too short Insufficient electrodes force Material is dirty 	

4. MAINTENANCE INSTRUCTIONS

4.1 MAINTENANCE INFORMATION

Maintenance personnel must be qualified, know the welding machine and work without modifying the safety of the product. The maintenance person must also respect the general accident prevention rules and regulations.

Small maintenance jobs

Use a fine grain file to keep the electrode tips free from ferrous waste and from the small craters that form. Restore electrode diameter to its original size because welding tends to widen it.

4.2 GUIDE TO MAINTENANCE

Daily checks

- clean surfaces that are dirty with oil, grease and water.
- clean the area around the welding machine
- clean any transparent guards
- make sure that all the protection devices are in their place and working properly

Attention: do not squirt jets of water on the welding machine
do not use solvents to clean the painted parts

Electrical system and welding control unit

- check condition of the protection circuit and tightness of the "PE" terminal
- check condition of the electric contacts (microswitches)
- check condition of the setting keypads/potentiometers
- see if there is any noise coming from secondary connections that have not been fixed properly
- check that all the signalling lights are in proper working order

Compressed air circuit

- check for any air leaks
- check line pressure, welding pressure, force on the electrodes
- empty the air line filter
- check lubricator oil level (if there is one)

Mechanical parts

- lubricate the cylinder rod
- check tightness of the components: cylinder, arm holder, arms, electrode holder

Weekly checks

- check any unusual operations with the operator
- remove oil stains from the welding area floor
- check for any air leaks

Electrical system and control unit

- check the microswitches
- check to see if any unauthorised changes have been made to the programming parameters.

Electrodes and electrode holder

- carry out an internal inspection of the electrodes and electrode holder
- clean the electrodes, electrode holder, clamps
- check parallelism of the arms in the welding position

Compressed air circuit

- check tightness of connections
- check tightness of the cylinder screws

Six-monthly checks

Electrical system

- clean all the contacts of the secondary circuit to remove corrosion with fine grain abrasive material
- tighten all connections
- check protection devices and overloads (thermostats)
- check welding parameters and correct them if necessary
- check tightness of the power, transformer and welding control unit terminals

Compressed air circuit

- check the proper working order of the filter-regulator-gauge (FRG) unit
- change any damaged connections
- empty the air line filter

When the welding machine is not going to be used

If the welding machine is not going to be used for some time there are a few things that need doing to prevent damage:

- lock the cylinder in the completely retracted position
- if the machine has to be stored away protect it by wrapping it with a protective film
- the welding machine must be stored in a dry place
- protect unpainted parts from dirt and corrosion

4.3 SPARE PARTS

For basic spare parts for those parts subject to wear and tear and for the machine's safety devices, contact an authorised dealer.

4.4 TECHNICAL ASSISTANCE

If the problem you have with the welding machine is not mentioned in the TROUBLESHOOTING table then contact an authorised dealer.