

LISTA RICAMBI - SPARE PARTS LIST - LISTA PIEZAS DE REPUESTO



TYPE OF EQUIPMENT

MODEL

TIG/MMA WELDING INVERTER

COMPACT EVO 406C 400V

SERIAL NO. FROM H-19-303842	PAGE No. 1 of 2	CODE 99815043	WIRING S9810049	PARTS E9815029	DATE 15/10/2021
			DIAGRAM	DRAWING	

No.	P/N	DESCRIZIONE ARTICOLO	ITEM DESCRIPTION	DESCRIPCIÓN DEL ARTÍCULO	QTY
01	21600055	CUFFIA X MANIGLIA TUBO OVALE 30X18	HANDLE FOR COMPACT SERIES		2
02	33830008	MANICO IN ALLUMINIO X COMPACT 350 L=263	ALUMINIUM HANDLE L=263		1
03	05000693	COPERCHIO COMP.406-416-PC76-86 ROSSO-RAG	RED COVER PANEL COMPACT 406-416-PC76-86		1
04	05000697	FIANCATA SX COMPACT 406C HELVI	LEFT SIDE PANEL COMPACT 406C HELVI		1
05	05000696	FIANCATA DX COMPACT 406C HELVI	RIGHT SIDE PANEL COMPACT 406C HELVI		1
06	22735784	SCHEDA ALIMENTAZIONI CNT 3PH STM32	CONTROL SUPPLY PCB 3PH STM32		1
07	22735731	SCHEDA CONTROLLO COMPACT 400A USB	CONTROL PCB COMPACT 400A USB		1
08	22735767	SCHEDA REMOTE CONTROLL COMPACT STM32	REMOTE CONTROL PCB FOR COMPACT		1
09	33640695	STAFFA SUPPORTO TRASF.TOROIDALE PC 75	METAL SUPPORT FOR TOROID TRAFO		1
10	26078043	TRASF.TOROIDALE INV.3PH COMPACT 416 EVO	TOROIDAL TRANSFORMER COMPACT 416 EVO		1
11	22735759	SCHEDA COND.+VIN SENSE HF TRIGER 3PH 3+3	CAPACITOR + VIN SENSE PCB		1
12	22735696	SCHEDA FILTRO INGRES. 3PH 270 ECO FIX.M4	INPUT FILTER PCB 3PH 270 ECO FIX.M4		1
13	22100009	PRESA DINSE FISS.PIC.50MMQ TBE35-50 CX58	50SQMM. DINSE SOCKET TBE35-50 CX58		2
14	22910023	ATTACCO MASCHIO M12X1 + PORTATUBO	GAS CONNECTOR M12X1 (MALE)		2
15	40211821	CABLAG.CONNETTORE 12 POLI COMPACT 416HF	12 POLE CONNECTOR WIRE HARNESS COM.416HF		1
16	21690655	FERITOIA ANTERIORE INV. COMPACT (PA6)	PLASTIC FRONT VENT-HOLE		1
17	21690781	MANOPOLA D.33 ROSSA-NERA C/BOCCOLA D.6,4	KNOB D.33 RED-BLACK WITH BUSHING D.6,4		1
18	04600400	KIT CORNICE+TAPPI COMPACT 406 C/TRAVERSO	KIT PLASTIC FRAME+CAPS		2
19	05000703	FRONTALE COMPACT 406C	FRONT PANEL COMPACT 406C		1
20	77650554	TARGA FRONTALE COMPACT 406C EVO	COMPACT 406C EVO FRONT LABEL		1
21	22735849	SCHEDA FRONTALE COMPACT	FRONT PANEL PCB COMPACT		1
22	26075019	.SONDA DI CORRENTE 500A 4V OFFSET 20MV	.HALL PROBE 500A 4V OFFSET 20MV		1
23	33820233	SBARRA RAME 3X15 L=120	COPPER BAR 3X15 L=120		1
24	33820234	SBARRA AL 4X15 L=120	ALUMINIUM BAR 4X15 L=120		2
25	26015017	MODULO MCF 300-04B SS5 FIX5/IS/B SCOMES	MCF MODULE 300-04B SS5 FIX5/IS/B		3
26	22735858	SCHEDA SNUBBER SECONDARI COMPACT	SNUBBER PCB SECONDARY		1
27	40290189	DIVISORIO ASSEMBL.COMPACT EVO 406C-416HF	ASSEMBLED INTERNAL PANEL COMPACT 406/416		1
28	33640781	STAFFA SUPERIORE ASSEMBLAG. MODULO PC 85	TOP ASSEMBLY BRACKET FOR PC 85 MODULE		1
29	22205205	COMMUTATORE 25A A 2503 SPORG.ALB./18MM	SWITCH 25A A 2503		1
30	05000704	RETRO COMPACT 406 C SERIGRAFATO	BACK PANEL COMPACT 406 C W/SCEEN PRINT.		1
31	33740674P9005	MASCHERINA COPRIFORO COLL.R.A. NERO-POL.	COVERING PLATE FOR WATER COOLER CONNEC.		1
32	21690654	FERITOIA POST.INV.COMPACT CON FORO (PA6)	PLASTIC BACK VENT-HOLE		1
33	21690371	MANOPOLA ROSSA X COM.PERNO 5 MM B-G1470R	RED SWITCH KNOB		1

PROPRIETA' ESCLUSIVA & CONFIDENZIALE: questo documento contiene informazioni riservate di proprietà esclusiva di HELVI S.p.A. e non può essere duplicato o inviato a parti terze o usato per altri scopi senza il previo consenso scritto di HELVI S.p.A.

PROPRIÉTÉ EXCLUSIVE ET RÉSERVE: ce document contient des informations réservées de propriété exclusive de HELVI S. p. A. et ne doit pas être photocopié, communiqué à tiers ou utilisé pour autres buts sans l'expresse permission écrite de HELVI. S.p.A.

AUSSCHLIEßENDES EIGENTUM & VERTRAULICHKEIT: dieses Dokument enthält reservierten Informationen, die von ausschließendem Eigentum von HELVI S. p. A. sind. Diese Informationen dürfen nicht reproduziert, zu anderen Parteien mitgeteilt oder für irgendeinen Zweck ohne ausdrückliche geschriebene Erlaubnis von HELVI S.p.A. benutzt werden.

HELVI S.p.A. si riserva il diritto di modificare qualsiasi informazione qui sopra senza preavviso a seguito di possibili migliorie ai propri prodotti. Questo documento, le informazioni qui riportate e/o allegate sono soggetti alle condizioni generali di vendita in vigore con Voi.

En raison des constantes améliorations HELVI S.p.A. se réserve le droit de modifier n'importe quelles informations ci dessus sans notification préalable. Ce document, les informations rapportées et/ou annexées sont assujetties aux conditions générales de vente en vigueur avec Vous.

Auf Grund beständiger Verbesserungen HELVI S. p. A. reserviert das Recht, irgendetwas vom oben ohne vorherige Ankündigung zu ergänzen oder zu ändern. Dieses Dokument, die berichteten bzw. eingeschlossenen Informationen sind abhängig von der allgemeinen Verkaufsbedingungen in Kraft mit Ihnen.

LISTA RICAMBI - SPARE PARTS LIST - LISTA PIEZAS DE REPUESTO



TYPE OF EQUIPMENT

MODEL

TIG/MMA WELDING INVERTER

COMPACT EVO 406C 400V

SERIAL NO. FROM H-19-303842	PAGE No.2 of 2	CODE 99815043	WIRING DIAGRAM S9810049	PARTS DRAWING E9815029	DATE 15/10/2021
--------------------------------	----------------	------------------	----------------------------	---------------------------	--------------------

No.	P/N	DESCRIZIONE ARTICOLO	ITEM DESCRIPTION	DESCRIPCIÓN DEL ARTÍCULO	QTY
34	20220125	CAVO NEOPR.4X4 MT.3,3 SGUAINATO	INPUT CABLE 4X4 M3,3 W/OUT PLUG		1
35	21605040	PRESSACAVO M25X1,5	CABLE CLAMP M25X1,5		1
36	21420008	FER.TOROIDALE WURTH 742700790 13X26X28,5	TOROIDAL FERRITE 13X26X28,5		1
37	22800091	VENT. RAH1751B1-C1 230V AC 172X150X51(C)	FAN RAH1751B1-C 230V AC 172X150X51		1
38	33640767	CONVOGLIATORE PC 85 EVO	AIR FLOW DIRECTIONER PC 85 EVO		1
39	33820231	RADIATORE SEC. COMPACT 416 L=200 FRESATO	SECONDARY RADIATOR COMPACT 416 L=200		1
40	33820232	RADIATORE PRIM.COMPACT 416 L=215 FRESATO	PRIMARY RADIATOR COMPACT 416 L=215		1
41	26014019	PONTE 3PH MTS50.16SS5 FIX5 ALTO SCOMES	RECTIFIER 3PH MTS50.16SS5		1
42	04600581	KIT SCHEDA MOD.l@COM.416-PC86+IGBT+PONTE	PRIMARY MODULE ASSY PC86 W/IGBT+BRIDGE		1
43	05000690	FONDO COMPACT 416 HF	BOTTOM PANEL COMPACT 416HF		1
44	33640797	STAFFA INFERIORE ASS.MODULO COMPACT 416	LOWER ASSEMBLY BRACKET FOR COMPACT 416		1
45	44135191	IMPEDENZA PRIM.PC126 400V D.3,15CU 23X29	PRIMARY CHOK PC 126 D.3,15 CU 23X29		1
46	21690901	DIVISORIO VERTICALE COMPACT 416	VERTICAL INTERNAL PANEL COMPACT 416		1
47	33640789	STAF.SUP.IMPED.-SCHEDA HF COMPACT 416HF	CHOKE&HF PCB SUPPORT BRACKET COMPACT 416		1
48	44035142	IMPEDENZA HF PER INV. 270HF ECO	HF COIL		1
49	44155135	TRASFORM.COMPACT EVO 416 380/400V 40KHZ	TRANSFORMER COMPACT 416 380/400V 40KHZ		1
50	21420012	FERRITE TOROIDALE 14X22,4X13,3	TOROIDAL FERRITE 14X22,4X13,3		2
51	22735762	SCHEDA FILTRO USCITA INVERTER	OUTPUT FILTER PCB		1
52	22900036	ELETTRORIVALVOLA 230V 50/60HZ 9VA 1/8"FF	SOLENOID VALVE 230V 50HZ 9VA 1/8"FF		1
53	22910024	ATTACCO FEMM.M12X1 + PORTAT. D.7 ESAG.14	GAS CONNECTOR M12X1 (FEMALE)		2
54	22105166	CONNETTORE PL.12 POLI VOL.MAS.WA2012-10	12 PIN MALE PLUG		1

PROPRIETA' ESCLUSIVA & CONFIDENZIALE: questo documento contiene informazioni riservate di proprietà esclusiva di HELVI S.p.A. e non può essere duplicato o inviato a parti terze o usato per altri scopi senza il previo consenso scritto di HELVI S.p.A.

PROPRIÉTÉ EXCLUSIVE ET RÉSERVE: ce document contient des informations réservées de propriété exclusive de HELVI S. p. A. et ne doit pas être polycopié, communiqué à tiers ou utilisé pour autres buts sans l'expresse permission écrite de HELVI. S.p.A.

AUSSCHLIEßENDES EIGENTUM & VERTRAULICHKEIT: dieses Dokument enthält reservierten Informationen, die von ausschließendem Eigentum von HELVI S. p. A. sind. Diese Informationen dürfen nicht reproduziert, zu anderen Parteien mitgeteilt oder für irgendeinen Zweck ohne ausdrückliche geschriebene Erlaubnis von HELVI S.p.A. benutzt werden.

HELVI S.p.A. si riserva il diritto di modificare qualsiasi informazione qui sopra senza preavviso a seguito di possibili migliorie ai propri prodotti. Questo documento, le informazioni qui riportate e/o allegata sono soggetti alle condizioni generali di vendita in vigore con Voi.

En raison des constantes améliorations HELVI S.p.A. se réserve le droit de modifier n'importe quelles informations ci dessus sans notification préalable. Ce document, les informations rapportées et/ou annexées sont assujetties aux conditions générales de vente en vigueur avec Vous.

Auf Grund beständiger Verbesserungen HELVI S. p. A. reserviert das Recht, irgendetwas vom oben ohne vorherige Ankündigung zu ergänzen oder zu ändern. Dieses Dokument, die berichteten bzw. eingeschlossenen Informationen sind abhängig von der allgemeinen Verkaufsbedingungen in Kraft mit Ihnen.

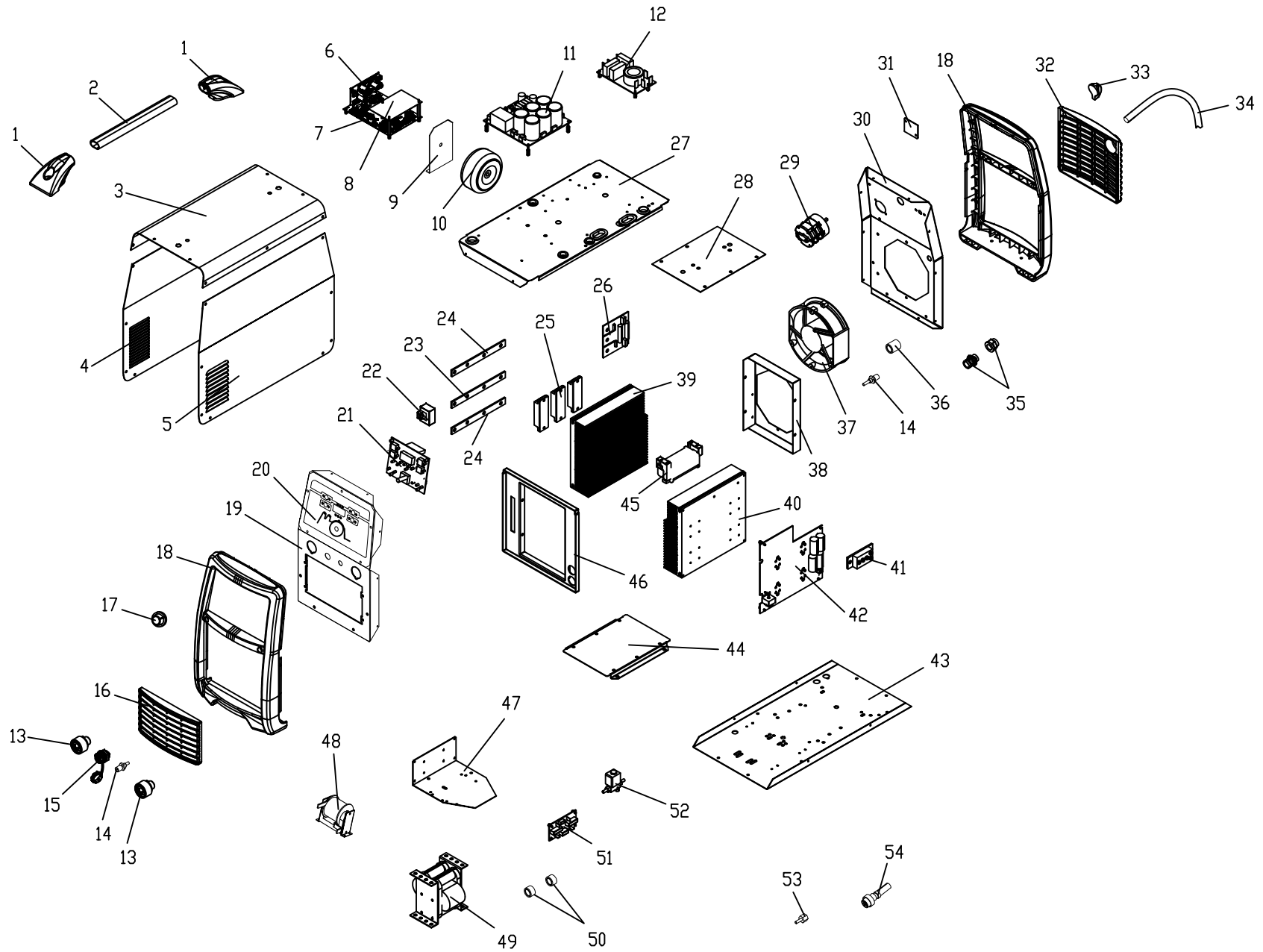

Denominazione

COMPACT 406C

Codice

E9815029

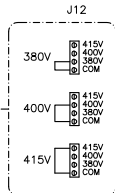
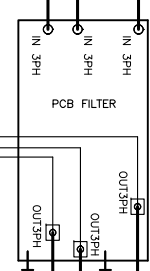
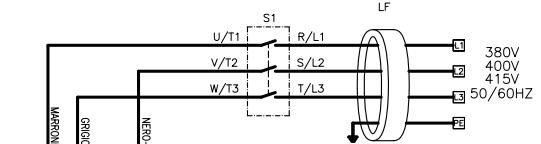
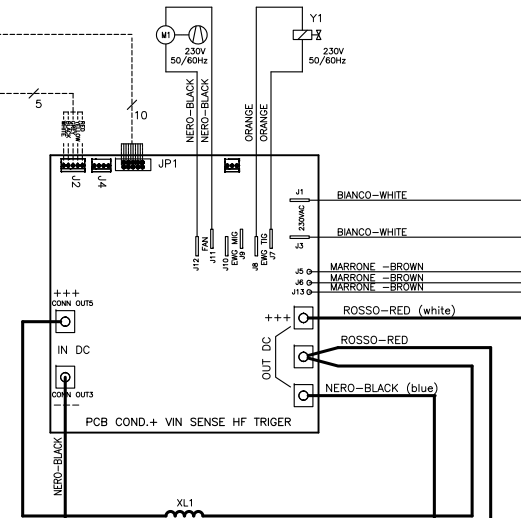
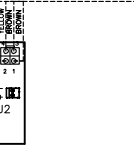
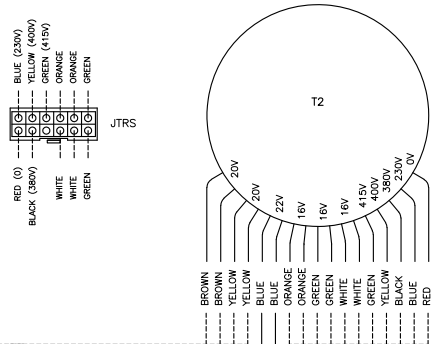
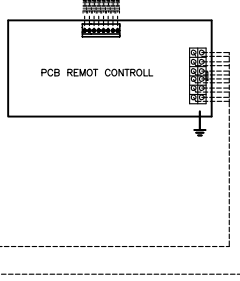
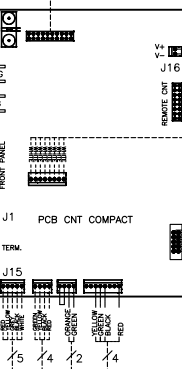
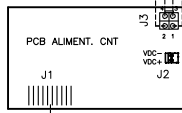
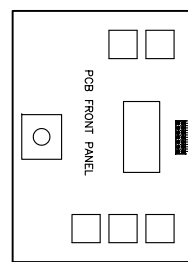
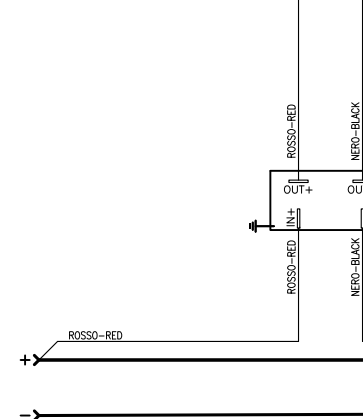
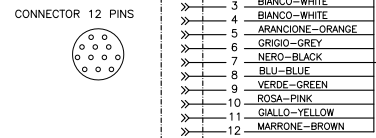
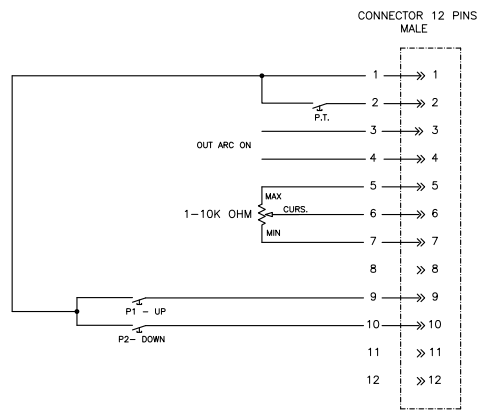

C1= KPR73-1000PF/10/1600 P15
 R1= 7CSN 10R NON INDUTTIVA
 D1= DIODO 1,5KE350CA BIDIREZIONALE
 VARISTOR= 14N911K

TH1	THERMOSTAT	THERMOSTATE	THERMOSTAT	TERMOSTATOS	TERMOSTATO
Y1	GAS SOLENOID VALVE	ELEKTROVENTJL	ELECTROVANNE	ELECTROVALVULA	ELETTROVALVOLA
LF	FILTER	FILTER	FILTRE	FILTRO	FILTRO
M1	FAN	VENTILATOR	VENTILATEUR	VENTILADOR	VENTILATORE
HP	HALL PROBE	STROMSONDE	SONDE DE COURANTE	SONDA DE CORRIENTE	SONDA DI CORRENTE

S1	SWITCH ON - OFF	UMSCHALTER EIN - AUS	COMMUTATEUR	INTERRUPTOR ON - OFF	INTERRUTTORE ON - OFF
T1	TRANSFORMER	TRANSFORMATOR	TRANSFORMATEUR	TRANSFORMADOR	TRASFORMATORE
T2	AUXILIARY TRANSFORMER	HILFSTRANSFORMATOR	TRANSFORMATEUR AUXILIAIRE	TRANSFORMADOR AUXILIARIE	TRASFORMATORE AUSILIARIO
XL1-XL2	CHOKE	IMPEDANZ	IMPEDANCE	IMPEDANCIA	IMPEDENZA