



PC EVO 70

PC EVO 100



Instruction manual

EN ENGLISH

Translation of the original
instructions in Italian

77613032
V.1.0 - 05/03/2024



Table of Contents

Foreword	4
Description	4
Installation	5
Positioning the generator	5
Connection to the line	5
Connections and sockets	7
Compressed air connection	8
earth cable connection socket	8
Plasma torch connection	8
Connection to automatic cutting systems	10
USER INTERFACE	11
Control panel	11
Switching on the system	12
Basic menu	12
Process selection menu	15
Cutting	15
Grid cutting	16
Gouging	16
CNC cutting	17
Adjusting the air flow (GAS)	17
System menu	18
Info	18
Alarm list	19
User manual	20
Service	20
CUTTING OPERATIONS	21
Manual cutting	21
Manual piercing with torch	22
Grid cutting	22
Gouging	22
Cutting with automatic cutting benches	23
MAINTENANCE	24
CUTTING DEFECTS	26
TORCH CONSUMABLE PARTS	28
EP 105	28
EPM 105	30
TECHNICAL DATA	32





Foreword

Before configuring and operating the new product, read the “General Prescriptions for Use” included in the packaging, paying special attention to the safety information.



Description

Plasma cutting is a process that uses a high-temperature plasma jet to cut electrically conductive materials. During the plasma cutting process, a gas (air) is forced through a nozzle into a high-temperature electric arc, creating plasma. This plasma is then concentrated on a certain spot of the material to be cut, generating enough heat to melt and cut the material. The molten plasma removes the material while the cut continues along the desired path.

PC70 and PC100 are plasma cutting systems suitable for a wide range of applications in which it is necessary to cut conductive metals such as carbon steel, stainless steel and aluminium.

The cutting thickness ranges from 25mm (30mm separation) for PC EVO 70 and 40mm (50mm separation) for PC EVO 100.



Installation



DANGER! Lifting and Positioning Read the warnings indicated by the following symbols in the “General Prescriptions for Use”.

Positioning the generator

Follow these guidelines to position your cutting system correctly:

- In places free from dust and moisture;
- At a temperature between 0°C and 40°C;
- In places protected from oil, steam and corrosive gases;
- In places not subject to particular vibrations or quakes;
- In places protected from sunlight and rain;

Make sure that no obstacles obstruct the flow of cooling air from the front and rear openings of the machine.

- Provide a clearance of at least 5 m around the machine.
- Whenever it is necessary to move the machine, always unplug it from the socket and pick up any pipes and hoses to prevent them from being damaged by passing over them.



Make sure that the cutting area is adequately ventilated. Inhaling cutting fumes can be dangerous.

Connection to the line



DANGER! Disconnect the equipment from the mains before performing any assembly operations. Closing the power switch does not guarantee disconnection from the mains.

Before making any electrical connection, check that the supply voltage and the available frequency correspond to those indicated on the generator nameplate.

The mains voltage should be within $\pm 10\%$ of the rated line voltage. Too low a voltage may result in poor performance; too high a voltage may, on the other hand, cause overheating and, as a consequence, the failure of some components.

The welding machine must be:

- Installed correctly, possibly by qualified personnel;
- Connected correctly, in accordance with local regulations;
- Connected to a socket of suitable capacity.

Connect the power cable to a standardised plug (3Ph + E) of suitable capacity.



Follow these instructions to connect the power cable to the plug:

- the brown wire must be connected to the terminal marked L1
- the blue or grey wire must be connected to the terminal marked L2
- the black wire must be connected to the terminal marked L3
- the yellow/green wire (earth) must be connected to the terminal marked PE or featuring the plug symbol

In all cases, the connection of the yellow/green earth wire to the PE terminal must be made in such a way that if the power cable is pulled out of the plug, it is the last one to be disconnected.

The socket to which the generator will be connected must be equipped with suitable protective fuses or a circuit breaker.

Notes:

- The power cable must be regularly checked for signs of damage or ageing. If it is not found to be in good condition, do not use the machine but have it repaired at a service centre.
- Do not tug on the power cable to disconnect it from the socket.
- Never run over the power cable with other machinery: you may damage it and there is a risk of electric shock.
- Keep the power cable away from heat sources, oils, solvents and sharp edges.
- When using an extension cable with a suitable cross-section, unwind the cable completely otherwise it might overheat.



Connections and sockets

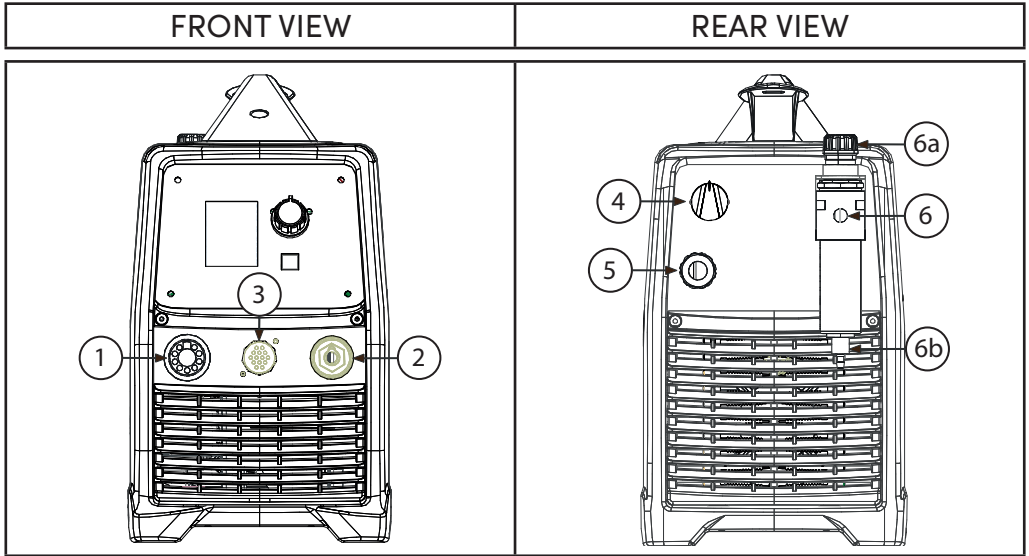

- 1 - Connection for PLASMA TORCH
- 2 - Socket for EARTH clamp
- 3 - Connector for Remote Control
- 4 - ON/OFF switch
- 5 - Power cable
- 6 - Pressure reducer. The pressure reducer is supplied without a quick coupling; the end user must provide an air connection that meets the system's requirements.
- 6a - Pressure reducer knob to adjust the compressed air pressure.
- 6b - Pressure reducer cup. It features the air filter inside.



Compressed air connection

Prepare a clean, dry compressed air or nitrogen distribution line with the following minimum characteristics.

Air pressure: 6–8 bar

Flow rate: 220 l/min for H.70 (HTM 70) and EP-105 (EPM 105).

Air hose diameter: Min. 8mm for H.70 (HTM 70) and EP-105 (EPM 105).

IMPORTANT: Failure to follow these instructions may cause overheating or damage to the torch.

A pressure reducer preset to an optimal value of 5 bar is supplied with the unit.

ATTENTION: the inlet air pressure must never be set above 8 bar.

The presence of oil or steam in the air can be a problem and must be avoided. The generator is equipped with a compressed air filter that captures steam and oils in the air. The collected steam can be automatically released by disconnecting the compressed air from the generator.

earth cable connection socket

- Connect the earth cable clamp to the workpiece to be cut or to the metal support bench, observing the following precautions:
- Check that good electrical contact is established especially if oxidised metal sheets or sheets with insulating coatings, etc. are cut.
- Make the earth connection as close as possible to the cutting area.
- The use of metal structures that are not part of the workpiece as a return conductor for the cutting current can be dangerous to safety and give poor cutting results.
- Do not make the earth connection on the part of the workpiece that is to be removed.

Plasma torch connection

Make sure that the machine is switched off and disconnected from the power supply. The torch, whether manual or automatic, is equipped with a “H Fit” quick-coupling system. Align the pins of the quick coupling correctly and connect it to the connector on the front of the machine by tightening the plastic ring nut.

IMPORTANT!: Before starting the cutting operations, make sure that the consumable parts are correctly assembled by inspecting the torch head as indicated in the “Torch Maintenance” paragraph.



NOTE: the tip, diffuser and electrode are held together in place by the nozzle. Position the torch with the nozzle facing upward to prevent these parts from falling when the nozzle is removed.

ATTENTION: Wait until the torch has cooled down completely before replacing the consumable parts to avoid damaging the torch body.

To change the consumable parts of the torch, follow this procedure:

- Unscrew and remove the bushing from the torch.
- Remove the hood, diffuser and electrode.
- Install the electrode, diffuser and hood. Tighten the bushing by hand until it is settled in its seat on the torch head. If the bushing meets resistance when it is installed, check the threads before proceeding.
- Install the spacer, where provided.

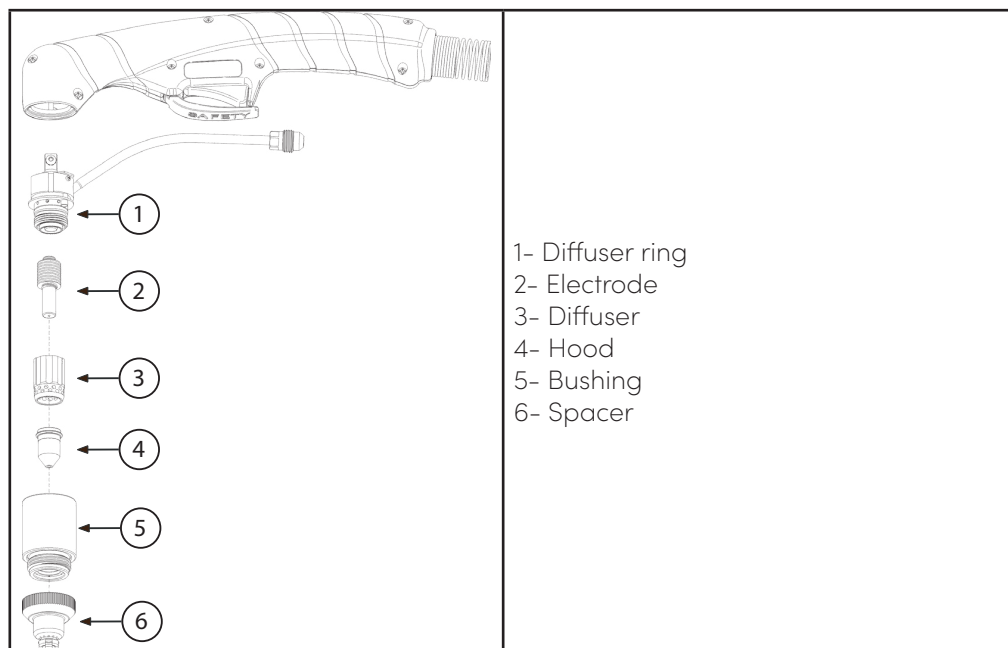
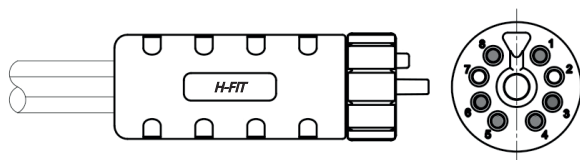



Connection to automatic cutting systems

The machine is set up for connection to automatic cutting systems.

- Make sure that the machine is switched off and disconnected from the power supply.
- The generator is equipped with a 14-pin male connector. Connect the control contact of the automatic cutting system to a 14-pin female connector compatible with the one installed on the machine according to the following diagram.
- Connect the male push-pull connector to the machine

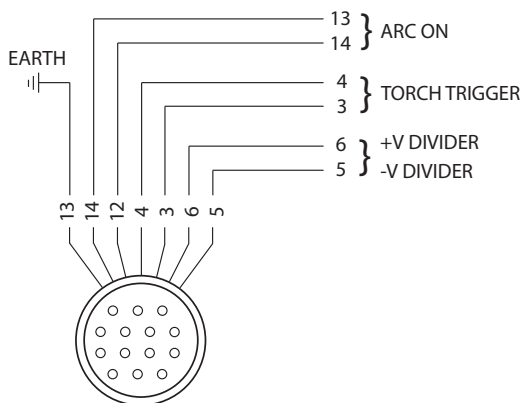

SIGNAL	I/O	Notes	PIN
Start	Input	Normally open clean contact	3
			4
Transfer	Output	Normally open clean contact that closes when the cutting arc transfers to the workpiece (machine movement start)	12
			14
Voltage divider	Output	Divided arc signal	5 (-)
			6 (+)
Earth		Earth	13



USER INTERFACE

Control panel

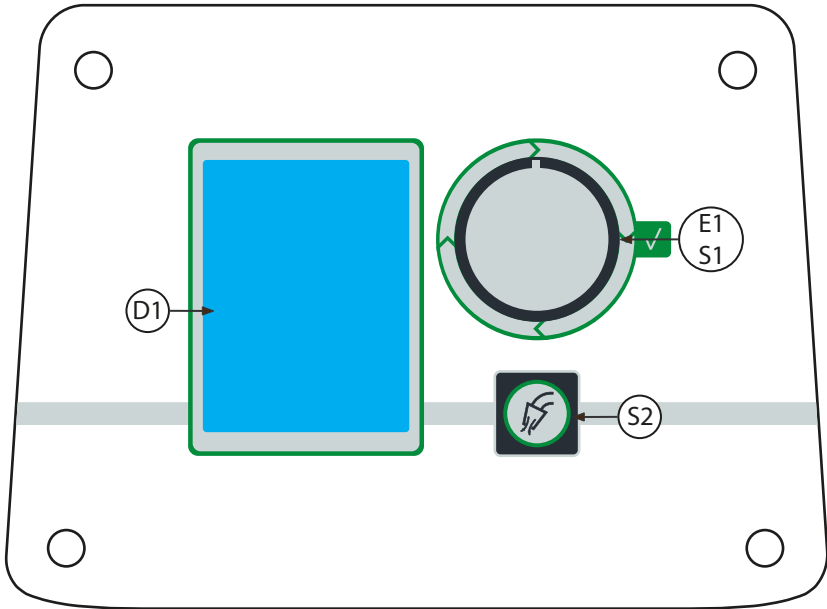

ACRONYM	DESCRIPTION
D1	The display shows the menus to set the generator and its functions. During cutting: The display shows the set cutting parameters.
E1/S1	ENCODER WITH KEY In setting/in cutting: allows for the cutting current to be adjusted On the menu pages: Use the encoder to scroll through the list of parameters/settings. Press the encoder (ENCODER KEY) to select the highlighted setting. - Press and hold for 3 seconds: the key calls up the cutting mode menu.
S2	AIR TEST key: The key activates the air solenoid valve to calibrate the flow pressure with the regulator located at the back of the generator.



Switching on the system

Set the generator power switch to "I" to switch on the equipment. The screen will display the Helvi brand name, the machine model, the SW version of the front panel, the board code, the SW version of the control board.

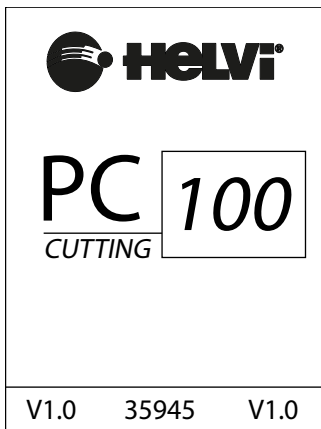

When switching on for the first time or after the RESET procedure: The generator is set up with the preset factory values.

Subsequent power-ups: The power generator is set up in the last configuration set before it was switched off.

Basic menu

Press S1 when the generator is switched on to enter the BASIC MENU.

BASIC MENU	
PREAIR	ON
TORCH LENG	6 M
TORCH AIR	EP105
TRIGGER IN	DEF
POWER LIMIT	OFF
DIVIDER	50
RESET	NO
Press ↵ to go back	



SETTING	VARIANTS	DEFAULT
PRE-AIR	ON - OFF	ON
TORCH LENGTH	6 - 10 - 20 - 30 M	6 M
TORCH TYPE	EP105 - URS15-20-25-30	EP105
TRIGGER INPUT	AUTO - DEFAULT	DEFAULT
POWER LIMIT	15KW - 17KW - OFF	OFF
DIVIDER	15 - 50	50
RESET	NO - YES	NO
BACKLIGHT	30% - 100%	80%

PRE-AIR

This item defines the activation of a pre-air safety device:

Off = the cutting arc starts immediately.

On = Pre-air before the start of the arc.

This function cannot be activated (off) for CNC cutting benches

TORCH LENGTH

This item defines the length of the torch.

The parameters that can be selected are 6, 10, 20 or 30 metres.

Depending on the torch type and length, the generator will indicate the most suitable pressure range.

TORCH TYPE

This item defines the torch type. Depending on the torch type, the generator will adjust the secondary parameters to optimise the performance and service life of the consumable parts.

EP105

URS -> (USERS) it is possible to adjust the pilot -> current between the following steps: 15-20-25-30

A higher pilot arc current facilitates the transfer of the arc onto the workpiece; conversely, it increases the consumption of the parts of the torch. Change this parameter only if necessary or if using torches other than those mentioned above.

The generator automatically recognises whether an EP105 torch is connected. In this case, the parameter will be set to EP105 and cannot be changed.

TRIGGER INPUT

This item defines the torch button input. It sets which PT (torch button) input to be used: Default -> Always uses the TORCH connector button; only if set to CNC, it uses the CNC connector button



Help -> the first button pressed (between torch and CNC) is automatically set.

POWER LIMIT

The generator power limit is used to protect the power grid from overloads due to the power consumption. Beware that a reduced power limit will compromise maximum cutting performance. Leave this limit at the maximum value to achieve maximum performance.

DIVIDER

The digital divider, which can be set from the panel, allows for part of the cutting voltage (according to the cutting voltage / divider formula) to be available on the CNC connector. For example, assuming a divider set to 50, if during cutting the arc voltage is 150V, the voltage available on the connector will be 3V.

RESET

This procedure is useful in the following cases:

- Too many changes to the cutting parameters and difficulty in re-establishing the factory parameters.
- Unidentified software problems preventing the proper operation of the power generator.

The reset procedure restores the values of the parameters and settings, except for the Alarm List.

After selecting YES and confirming by pressing S1, the page showing the progress of the RESET procedure appears.

When the RESET procedure is complete, the machine sets up the BASIC MENU.

Press S2 to exit the BASIC MENU.



Process selection menu

Press S1 and hold it for 3 seconds to enter the process selection page:

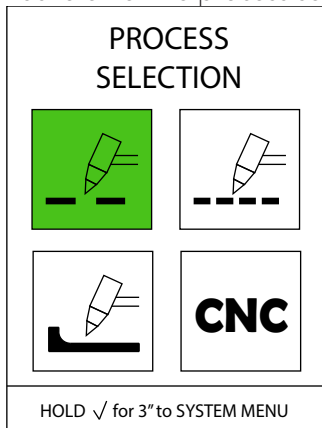

Use Encoder E1 to select the desired process from the following options:

- CUTTING
- GRID CUTTING
- GOUGING
- CNC CUTTING

Press S1 to confirm the selection.

Cutting

From the PROCESS SELECTION MENU; if CUTTING is selected, the following screen appears:

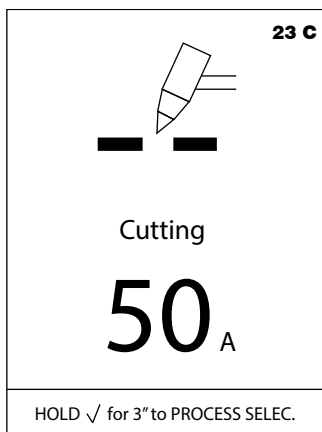

Set the current by turning Encoder E1.



Grid cutting

From the PROCESS SELECTION MENU; if GRID CUTTING is selected, the following screen appears:

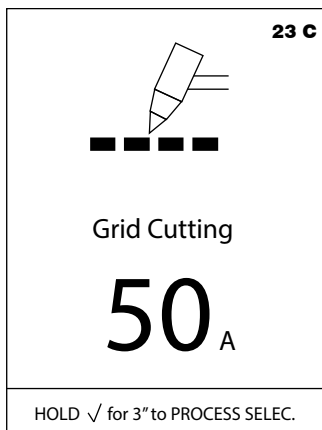

Set the current by turning Encoder E1.

Gouging

Plasma gouging is a process involving the melting and then removal of material. To carry out this type of processing, the nozzles of the torch and its gas diffusers are usually different and the torch must be held in a tilted position. In addition to this, the gas pressure is lower than the cutting pressure.

From the PROCESS SELECTION MENU; if GOUGING is selected, the following screen appears:

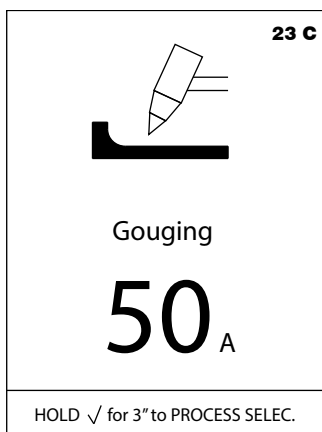

Set the current by turning Encoder E1.



CNC cutting

From the PROCESS SELECTION MENU; if CNC CUTTING is selected, the following screen appears:

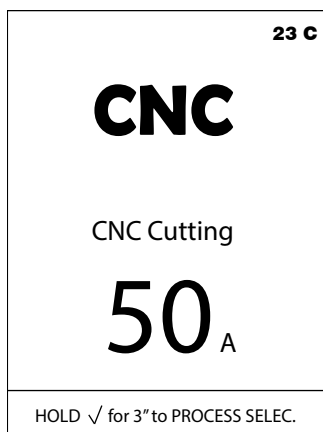

Set the current by turning Encoder E1.

For CNC cutting, connect the male push-pull connector to the machine.

Adjusting the air flow (GAS)

To adjust the air flow, it is necessary to press and release S2 to open the solenoid valve. Adjust the pressure of the air coming out of the torch by acting on the pressure regulator at the back of the machine. The set pressure value must be between the minimum and maximum limits indicated in the pressure bar shown on the generator display (the bar must be green).

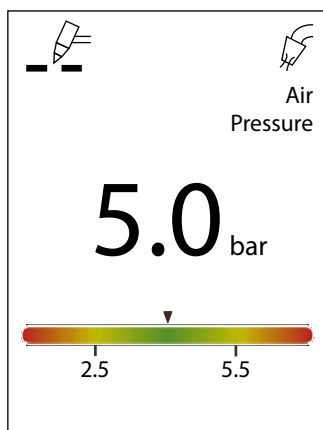

Close the solenoid valve by pressing and releasing S2. The solenoid valve closes automatically after 20 seconds.



System menu

Press S1 and hold it for 10 seconds to enter the SYSTEM MENU.

SYSTEM MENU
INFO
ALARM LIST USER MANUAL SERVICE
Press to go back

Select the desired item by turning Encoder E1:

Press S1 to confirm.

Press S2 to exit.

NAME	DESCRIPTION
INFO	INFO PAGE
ALARM LIST	LIST OF ALARMS
USER MANUAL	QR CODE
SERVICE	SERVICE PAGE

Info

The INFO page features the following information:

NAME	DESCRIPTION
POWER ON	Machine hours on
ARC ON	Arc hours on
PILOT ARC ON	Pilot arc hours on
FAN ON	Fan hours on
TURN ON N.	No. of times the machine was switched on
INTERNAL TEMP.	Heatsink temperature*

* The heatsink temperature value also appears in the top right corner of the Processes pages.



Press S2 to exit.

Alarm list

The ALARM LIST page shows the last 9 alarms, the top one being the most recent. When the alarm page is full, the oldest one disappears to make space for the most recent one.

TYPES OF ALARMS

When an alarm is generated, the WARNING page appears if the alarm can be reset, or the ALARM page if it is a persistent alarm; a symbol, the code and description of the alarm are displayed.

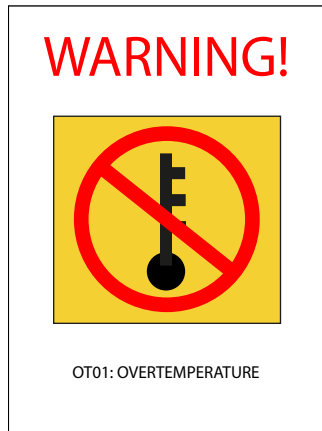

CODE	DESCRIPTION
AIH	Air pressure too high
AIL	Air pressure too low
Bxx	Generic alarm
FPP	Primary power fault
FPR	Primary frequency fault
IOV	Output overcurrent alarm
EN	Cutting current alarm
NTC	NTC fault
OIE	Power-on current offset alarm
Otx	Thermal protection alarm
PDW	Microcontroller power supply fault
TOR	Torch not detected



Press S2 to exit.

User manual

This page features the QR CODE that sends you to the Helvi website where the manual can be downloaded.



Press S2 to exit.

Service

The SERVICE page is used for generator diagnostics and it is reserved for adequately trained technicians.

Press S2 to exit.



CUTTING OPERATIONS

Manual cutting

Torches for manual cutting are equipped with a safety button to prevent them from being switched on accidentally.



ATTENTION! Disconnect the generator from the power supply before removing the torch or its connections. Frequently re-read the Safety Precautions in the “General Prescriptions for Use” manual. Make sure that the operator is wearing suitable gloves, clothing, eye protection and hearing protection.

Make sure that no part of the operator’s body comes into contact with the workpiece while the torch is active.

Select CUTTING mode from the Process Selection menu.

To start cutting from the edge of the workpiece, hold the torch perpendicularly and with the front part of the tip on the edge of the workpiece at the point where you want to start cutting.

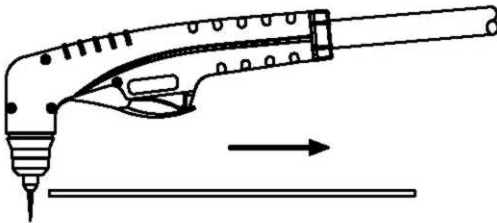

With the torch in the start position, press the torch button. After air is released for 3 seconds (pre-air), the pilot arc will light and remain lit until the cutting arc is triggered. Once the main arc is lit, it will remain lit as long as the control button is pressed, unless the torch is removed from the workpiece or the torch movement is too slow. Keep moving while cutting. Maintain a constant speed, so that the arc angle is 30° behind the cutting direction.

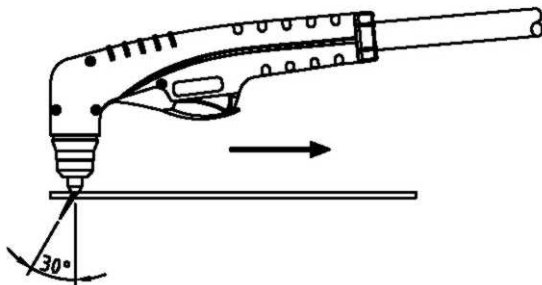

If the cutting arc is interrupted and the torch button is pressed, the pilot arc is automatically triggered again for 3 seconds.

To switch off the torch, simply release the control button. When the button is released,



there will be a few seconds of post-flow. If the torch button is pressed during the post-flow, the pilot arc will be triggered again.

Manual piercing with torch

Note: The maximum piercing capacity depends on the torch and on the generator cutting current. Refer to the torch specifications supplied with the generator. Should it be necessary to pierce a thickness greater than the maximum capacity indicated, it is advisable to first use a drill to create a hole that is at least \varnothing 6mm, and use that as a starting point.

When piercing manually with a torch, tilt it slightly.

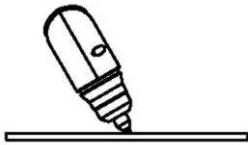

Complete the piercing outside the cutting line and then continue cutting on the line. Hold the torch perpendicular to the workpiece after it has been pierced.

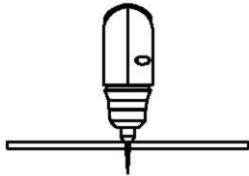

Remove any spatter and deposits from the nozzle as soon as possible.

Grid cutting

Select GRID CUTTING mode from the Process Selection menu.

In this mode, the pilot arc remains lit as long as the torch button is pressed; the arc naturally switches from pilot arc to cutting arc depending on the presence of the sheet metal to be cut.

Gouging

Select GOUGING mode from the Process Selection menu.

Hold the torch with the tip 1.5 mm from the workpiece.

Hold the torch at a 45° angle with respect to the workpiece.

Press the torch button to trigger the pilot arc. Transfer the arc to the workpiece.

Pull the torch back while maintaining a 45° angle with respect to the workpiece and a certain distance between the torch tip and the molten metal in order not to reduce the service life of the consumable parts or damage the torch.

Changing the angle of the torch changes the size of the gouging.

The gouging profile can vary depending on:



- the speed of the torch on the workpiece
- the distance from the workpiece
- the angle of the torch with respect to the workpiece
- the set output current.

To increase the width:

- Increase the distance and/or the current.
- Decrease the speed and/or the angle.

To decrease the width:

- Increase the speed and/or the angle.
- Decrease the distance and/or the current.

To increase the depth:

- Decrease the speed and/or the distance.
- Increase the current and/or the angle.

To decrease the depth:

- Decrease the current and/or the angle.
- Increase the speed and/or the distance.

Cutting with automatic cutting benches

Select CNC CUTTING mode from the Process Selection menu.

Follow the instructions in the "Connection to automatic cutting systems" paragraph.

Since the generator with mechanised torch can be used with different cutting tables, consult the Manufacturer's instructions to perform operations in this configuration.



MAINTENANCE

Maintenance operations on the generator can only be performed by technicians with the necessary technical knowledge and equipment, otherwise contact your local service centre.

ATTENTION! Do not, for any reason, access the inside of the power source (by removing the panels) or perform operations on the torch (disassembly) without previously unplugging it from the socket. Any checks performed with live parts inside the machine or torch can cause severe electric shock originating from direct contact with live parts.

UNIT

Inspect the generator every 3-4 months (also depending on how much it is used) and remove any dust deposits with compressed air.

ATTENTION! Use only dry compressed air for cleaning. Do not point the jet directly at the electronic circuits.

TORCH

Periodically, depending on how much it is used or in the event of cutting defects, check the condition of the parts of the torch affected by the plasma arc:

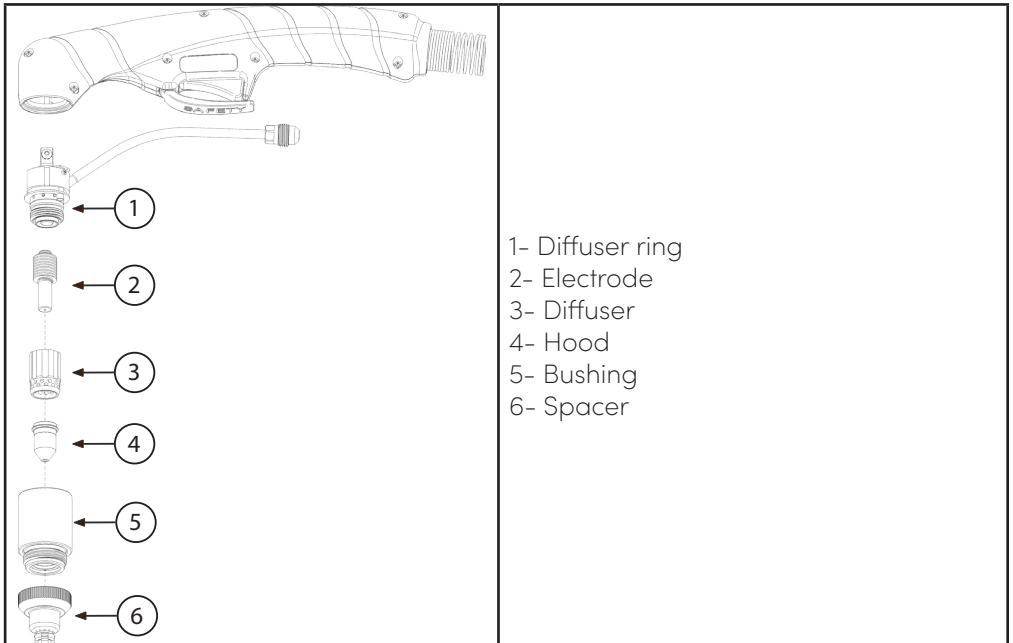

Bushing: Manually unscrew the torch head. Thoroughly clean it or replace it if damaged (burns, deformations or cracks). Check the integrity of the upper metal sector (torch safety actuator).



Hood: Check the condition of the plasma arc passage hole and the inner and outer surfaces. If the hole seems to be wider than the original diameter or deformed, replace the hood. If the surfaces are particularly oxidised, clean them with very fine sandpaper.

Air diffuser: Check that there are no burns or cracks and check that the air passage holes are not clogged. If damaged, replace it immediately.

Electrode: Replace the electrode when the depth of the crater formed on the emitting surface is about 2mm.

ATTENTION! Before performing any operations on the torch, allow it to cool down at least for the entire "post-air" phase;

Except for special cases, it is advisable to replace the electrode and the tip at the same time;

Observe the order in which the torch components are assembled (in reverse order compared to disassembly);

Take care that the distributor ring is installed in the correct direction;

Refit the nozzle by screwing it in by hand, forcing it slightly.

Under no circumstances assemble the nozzle without first having assembled the electrode, trigger device, diffuser and tip;

The timeliness and correct procedure of the inspections on the consumable parts of the torch are essential for the safety and functionality of the cutting system.

TORCH BODY, HANDLE AND CABLE

Usually these components do not require special maintenance except for periodic inspections and thorough cleaning to be carried out without using solvents of any kind. If the insulation is found to be damaged (fractures, cracks and burns or loosening of electrical conduits), the torch can no longer be used since the safety conditions are not met. In this case, the repair (extraordinary maintenance) cannot be carried out on site, but it must be delegated to an authorised service centre that is capable of carrying out the special acceptance tests after repair.

In order to keep the torch and the cable in good working order, it is necessary to take some precautions:

DO NOT bring the torch and the cable into contact with hot or red-hot parts.

DO NOT subject the cable to excessive tensile stress.

DO NOT run the cable over sharp, cutting edges or abrasive surfaces.

Gather the cable in regular coils if it is longer than required.

DO NOT run over the cable with other machinery.

COMPRESSED AIR FILTER

The generator is equipped with a compressed air filter that captures condensate and oil. Steam or oil is released from the filter automatically by disconnecting the compressed air from the machine.



CUTTING DEFECTS

Some performance imperfections may arise during cutting operations, which may be caused by factory malfunctions or other operational defects, such as:

Insufficient penetration:

- cutting speed too high;
- torch too tilted;
- workpiece too thick;
- cutting current too low;
- worn torch parts;
- non-original spare parts;

Cutting arc interruption:

- cutting speed too low;
- excessive distance between torch and workpiece;
- AC line too low - reduce output current;
- worn torch parts;
- non-original spare parts;
- earth cable disconnected;

Excessive slag formation:

- cutting speed too low (lower slag);
- cutting speed too high (upper slag);
- excessive distance between torch and workpiece;
- cutting current too low;
- worn torch parts;
- non-original spare parts;

Cut at an angle (not perpendicular):

- incorrect torch position;
- incorrect and/or asymmetric wear of the nozzle hole;
- assembly of torch parts;

Excessive nozzle and electrode wear:

- air pressure too low;
- exceeded system capacity (material too thick);
- contaminated air (moisture - oil);
- excessive triggering of pilot arc in air;
- torch not assembled properly;
- torch tip in contact with the workpiece;
- missing or damaged torch head components;
- non-original spare parts.





TORCH CONSUMABLE PARTS

EP 105

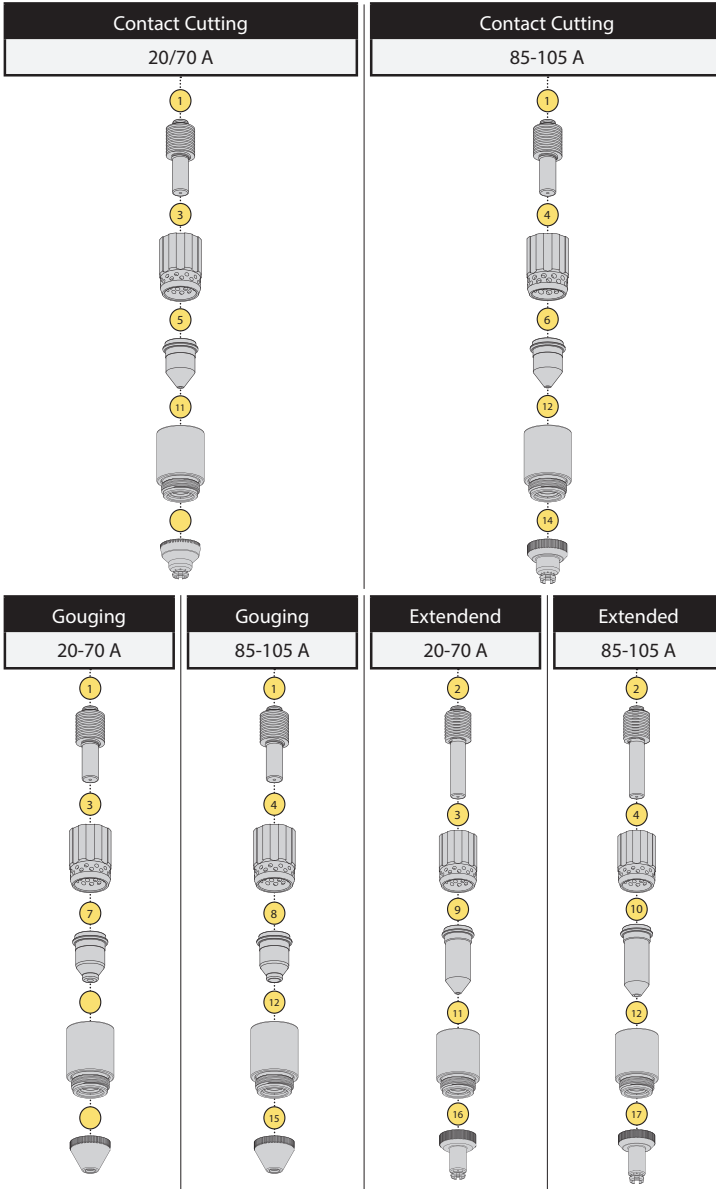



Pos.	Description	Blyster/Q.ty		Part Number
1	Electrode	A	10 pcs	23015354BH
2	Electrode	A	5 pcs	23015361BH
3	Swirl ring	D	2 pcs	23015355BH
4	Swirl ring	A	2 pcs	23015517BH
5	Tip 20/70 A	A	10 pcs	23015357BH
6	Tip 85/105 A	A	10 pcs	23015519BH
7	Tip 20/70 A	A	10 pcs	23015411BH
8	Tip 85/105 A	A	10 pcs	23015567BH
9	Tip 20/70 A	F	5 pcs	23015363BH
10	Tip 85/105 A	A	5 pcs	23015568BH
11	Retaining cap 20/70 A	D	1 pcs	23015358BH
12	Retaining cap 85/105 A	D	1 pcs	23015565BH
13	Shield cap	D	2 pcs	23015359BH
14	Shield cap	D	3 pcs	23015524BH
15	Shield cap	D	2 pcs	23015412BH
16	Shield cap	D	2 pcs	23015364BH
17	Shield cap	D	3 pcs	23015569BH



EPM 105

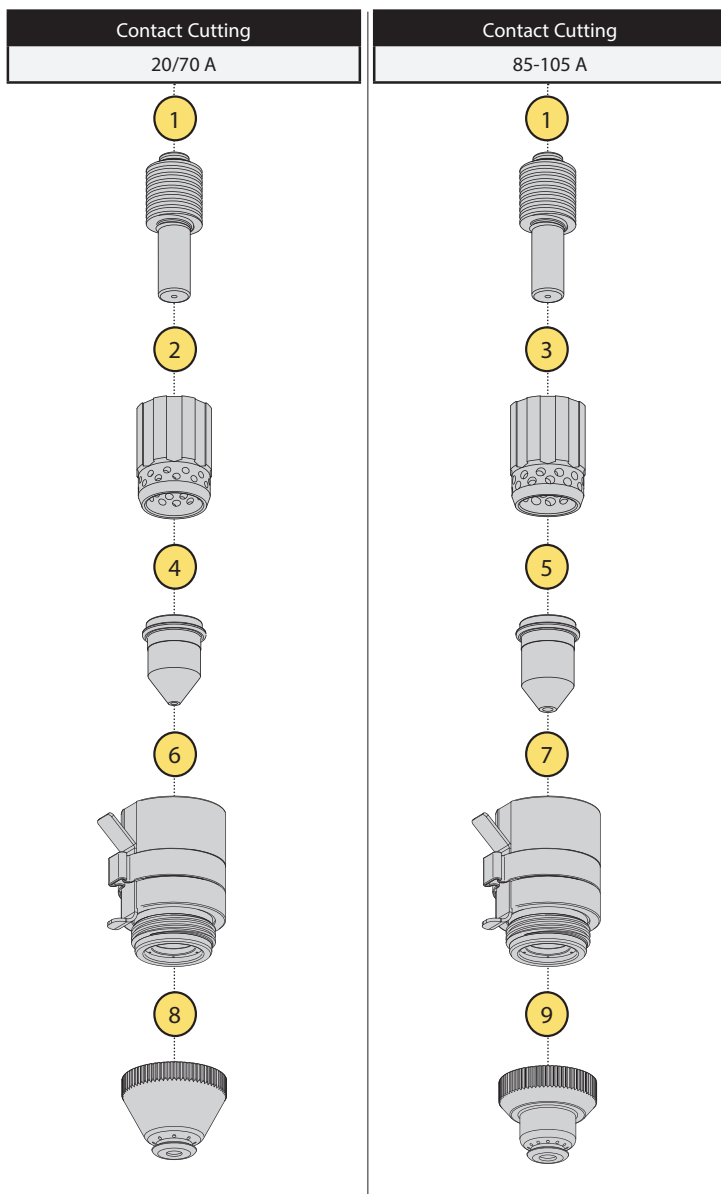



Pos.	Description	Blyster/Q.ty		Part Number
1	Electrode	A	10 pcs	23015354BH
2	Swirl ring	D	2 pcs	23015355BH
3	Swirl ring	A	2 pcs	23015517BH
4	Tip 20/70 A	A	10 pcs	23015357BH
5	Tip 85/105 A	A	10 pcs	23015519BH
6	Retaining cap 20/70 A (V Sensor)	D	1 pcs	23015570BH
7	Retaining cap 85/105 A (V Sensor)	D	1 pcs	23015571BH
8	Shield cap	D	2 pcs	23015360BH
9	Shield cap	D	2 pcs	23015527BH



TECHNICAL DATA

Construction Standards	EN 60974-1; EN 60974-10 Class A
Implemented Directives 1	2014/30/EU (EMC)
	2014/35/EU (LVD)
	1907/2006 (REACH)
	2011/65/EU (RoHS2)
	2009/125/EU (Ecodesign)

PC EVO 70

Mains voltage	(3ph) 400V 50/60 Hz
Max power	8.9 KVA
Maximum initial current	22 A
No-load voltage	330 V
Min-Max amperage	20 - 70 A
Work cycle	70A @ 50%
	65A @ 60%
	50A @ 100%
Clean cut 25cm/min	25 mm
Maximum cutting capacity	30 mm
Separation	35 mm
Penetration	16 mm
Required air capacity	220 l/min @ 5 bar
Insulation class	H
Protection rating	IP 22S
Dimensions (LxWxH)	230x550x400 mm
Gross/net weight	23.6Kg / 20.4Kg



PC EVO 100

Mains voltage	(3ph) 400V 50/60 Hz
Max power	14.2 KVA
Maximum initial current	22 A
No-load voltage	320 V
Min-Max amperage	20 - 100 A
Work cycle	100A @ 35%
	70A @ 60%
	60A @ 100%
Clean cut 25cm/min	35 mm
Maximum cutting capacity	40 mm
Separation	50 mm
Penetration	20 mm
Required air capacity	220 l/min @ 5 bar
Insulation class	H
Protection rating	IP 22S
Dimensions (LxWxH)	230x550x400 mm
Gross/net weight	27.2Kg / 24Kg





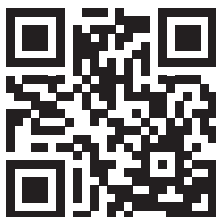

www.helvi.com



Helvi S.p.A.

Viale Galileo Galilei 123, - 36066 - Sandrigo (VI) Italy

Tel. (+39) 0444 666999 - Fax (+39) 0444 750 070

www.helvi.com - info@helvi.com
