

LISTA RICAMBI - SPARE PARTS LIST - LISTA PIEZAS DE REPUESTO



TYPE OF EQUIPMENT

MODEL

MULTIPROCESS WELDING INVERTER FOX 185 FLEX-LINE 115/230V

SERIAL NO. FROM H-15-308281	PAGE No. 1 of 2	CODE 99820039	WIRING DIAGRAM	S9820013	PARTS DRAWING	E9820033	DATE 23/05/2016
---------------------------------------	------------------------	-------------------------	--------------------------	-----------------	-------------------------	-----------------	---------------------------

No.	P/N	DESCRIZIONE ARTICOLO	ITEM DESCRIPTION	QTY
01	21690226	CHIUSURA A SLITTA A FILO	DOOR LATCH	1
02	33705703 3020	SPORTELLINO SX FOX 170/190 ROSSO	LEFT DOOR FOX 170/190 RED	1
03	21800069	VOLANTINO X ASPO MINI D.36 DADO M10 <=66	HAND WHEEL	1
04	33800043	MOLLA GREZ.EST.14X1,8X4,5SP.L=15,5 SPIAN	SPRING	1
05	21690715	ASPO MINI MOBILE X ROCCHETTI D.16-50	MINI SPOOL HOLDER RETAINING RING	1
06	55200645	PERNO ASPO MINI M10 L=87 ZN. 33810141	SPOOL HOLDER SHAFT M10 L=87MM	1
07	21690714	ASPO MINI FISSO X ROCCHETTI D.16-50	FIXED SPOOL HOLDER	1
08	22900009	ELETTRORVALVOLA 9W 24V DC 1/8"FF	SOLENOIDE VALVE 9W 24V DC 1/8"FF	1
09	22910004	RACCORDO PORTATUBO D.6 1/8"M	HOSE TAIL D.6 1/8"M	2
10	22735375	SCHEDA REGOLAZ. ESTERNA BBT-SLOPE X FOX	SLOPE EXTERNAL REGULATION PCB	1
11	21690737	MANOPOLA M1924 X ALB.D.6 CAPP/INDI ROSSO	KNOB M1924	2
12	21800067	POMELLO D.25 CON BOCCOLA FILETTATA M8	KNOB WITH THREADED BUSHING	2
13	04600412	KIT BASETTA GAS-NO GAS PER FOX	KIT GAS/NO GAS CHANGE BOARD	1
14	33720287 9005	DIVSORIO FOX PFC NO DEVIATORE NERO	BLACK INTERNAL PANEL FOX PFC	1
15	04600145	MOTORE D.37 + PIGNONE	MOTOR D.37 + PINION	1
16	44410033	MOTORID. PL./AL D.37 Siner. 2RUL. 06-08	WIRE FEEDER PLAST/ALL D.37 RUL.06-08	1
17	77650445	TARGA POLICARB. FOX 185 PFC 12POS. HELVI	FRONTAL PLATE FOX 185 PFC 12POS. HELVI	1
18	04600331	MANOPOLA D.26 X POTENZ. ROSSA + INDICE	RED KNOB D.26 FOR POTENTIOM. + POINTER	1
19	04600332	MANOPOLA D.32 X POTENZ. ROSSA + INDICE	RED KNOB D.32 FOR POTENTIOM. + POINTER	2
20	23005497	CANNETTA GUIDAFILO D.2X5 L=87	WIRE GUIDE TUBE D.2X5MM L=87MM	1
21	23005501	ATTACCO MINIEURO PUNG.L=32 +CAN.L=87	MIG GUN EURO CONNECTION L=32	1
22	22100002	PRESA DINSE FISSA 25MMQ TBEM25 CX30	FEMALE DINSE PLUG 25SQMM CX30	2
23	21690700B	GUSCIO ANTERIORE 2 DINSE + FORO AT.EURO	FRONT TRIM 2 DINSES + EURO PLUG HOLE	1
24	26075013	SONDA DI CORRENTE YNC-200A =012	HALL PROBE YNC-200A	1
25	22735573	SCHEDA FRONTALE FOX 185 PFC 12POS. HELVI	FRONT PC BOARD FOX 185 PFC 12POS. HELVI	1
26	33700365 9005	FONDO FOX 170 NERO	BOTTOM PANEL BLACK	1
27	22735443	MODULO INVERTER 160A PFC MIG/MMA 180PFC	POWER BOARD 160A PFC MIG/MMA	1
28	22225332	RELE ASIAON AS-50F 40A 24VDC	RELAY 40A 24VDC	1
29	22200047	INT.BIPOLARE NERO NO LUMINOSO C/PROTEZ.	BIPOLAR BLACK SWITCH W/PROTECTION	1
30	21605010	PRESSACAVO C/GHIERA "STEAB" X FORO D.20	CABLE CLAMP FOR HOLE D.20	1
31	20220022	CAVO PVC 3X2,5 MT.2,5 SPINA SHUCO	INPUT CABLE 3X2,5 M 2,5 WITH SHUKO PLUG	1
32	21690701A	GUSCIO POSTERIORE FOX 170 INT.CON PROT.	BACK FRAME FOX 170/180	1
33	21600060	CINGHIA FERMA CAVO X FOX 170 L=250 H=15	SECURING CABLE BELT	1

PROPRIETA' ESCLUSIVA & CONFIDENZIALE: questo documento contiene informazioni riservate di proprietà esclusiva di HELVI S.p.A. e non può essere duplicato o inviato a parti terze o usato per altri scopi senza il previo consenso scritto di HELVI S.p.A.

PROPRIÉTÉ EXCLUSIVE ET RÉSERVE: ce document contient des informations réservées de propriété exclusive de HELVI S. p. A. et ne doit pas être photocopié, communiqué à tiers ou utilisé pour autres buts sans l'expresse permission écrite de HELVI. S.p.A.

AUSSCHLIEßENDES EIGENTUM & VERTRAULICHKEIT: dieses Dokument enthält reservierten Informationen, die von ausschließendem Eigentum von HELVI S. p. A. sind. Diese Informationen dürfen nicht reproduziert, zu anderen Parteien mitgeteilt oder für irgendeinen Zweck

HELVI S.p.A. si riserva il diritto di modificare qualsiasi informazione qui sopra senza preavviso a seguito di possibili migliorie ai propri prodotti. Questo documento, le informazioni qui riportate e/o allegate sono soggetti alle condizioni generali di vendita

En raison des constantes améliorations HELVI S.p.A. se réserve le droit de modifier n'importe quelles informations ci dessus sans notification préalable. Ce document, les informations rapportées et/ou annexées sont assujetties aux conditions générales de vente

Auf Grund beständiger Verbesserungen HELVI S. p. A. reserviert das Recht, irgendetwas vom oben ohne vorherige Ankündigung zu ergänzen oder zu ändern. Dieses Dokument, die berichteten bzw. eingeschlossenen Informationen sind abhängig von der allgemeinen Verk

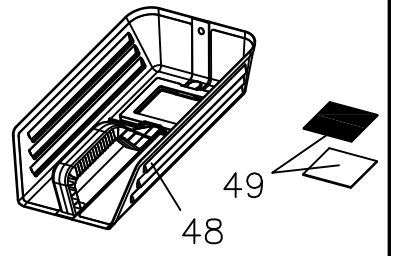
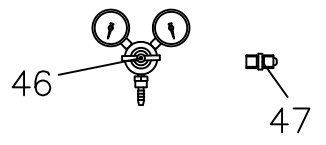
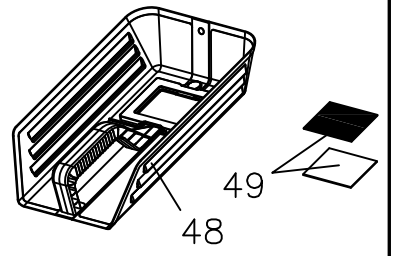
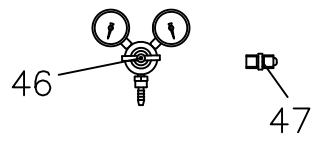
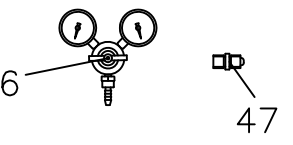
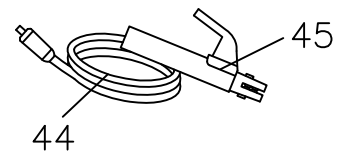
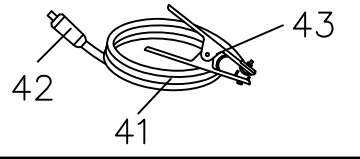
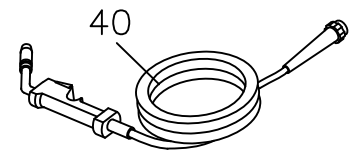
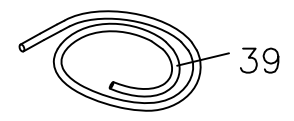
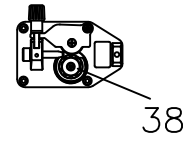
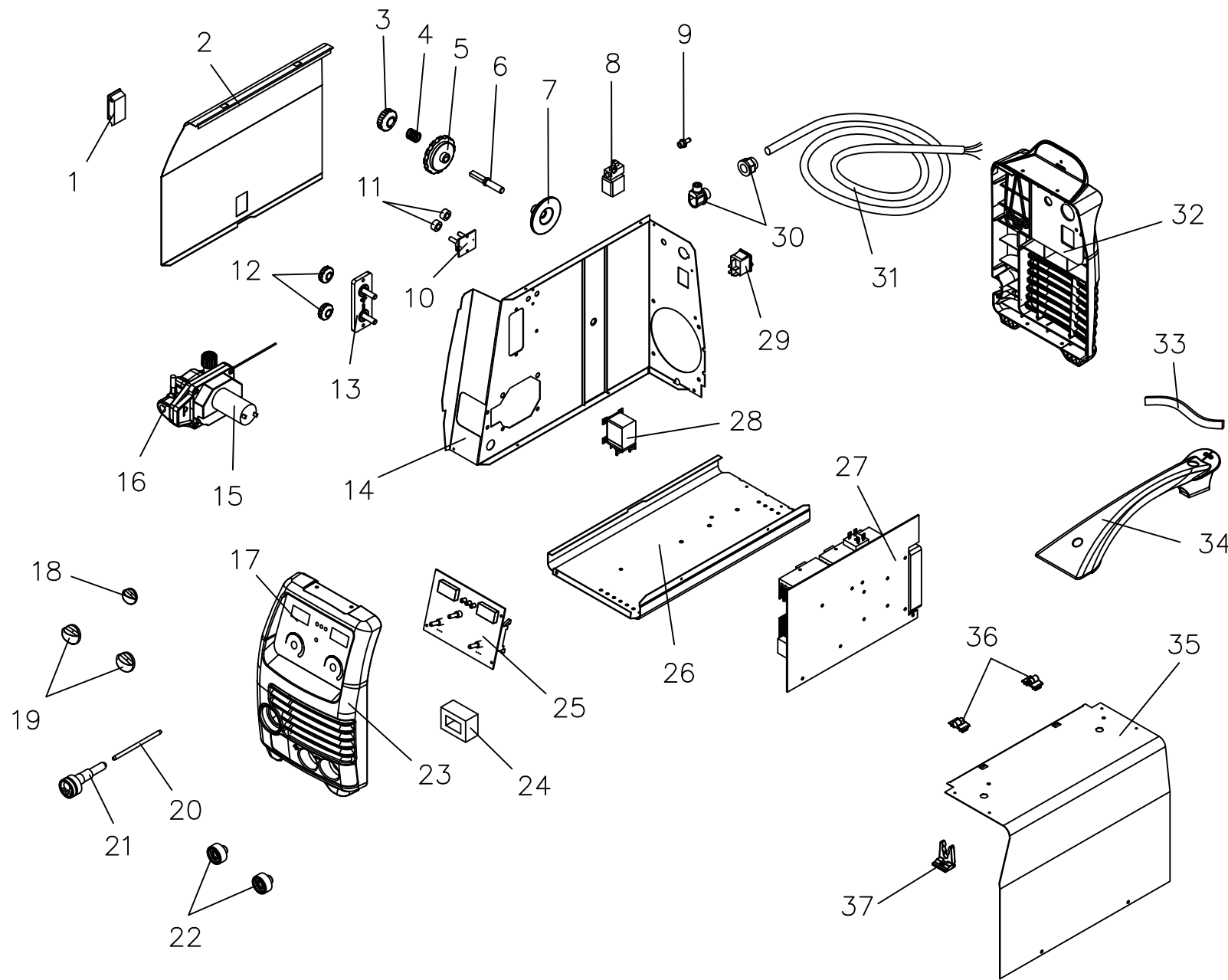

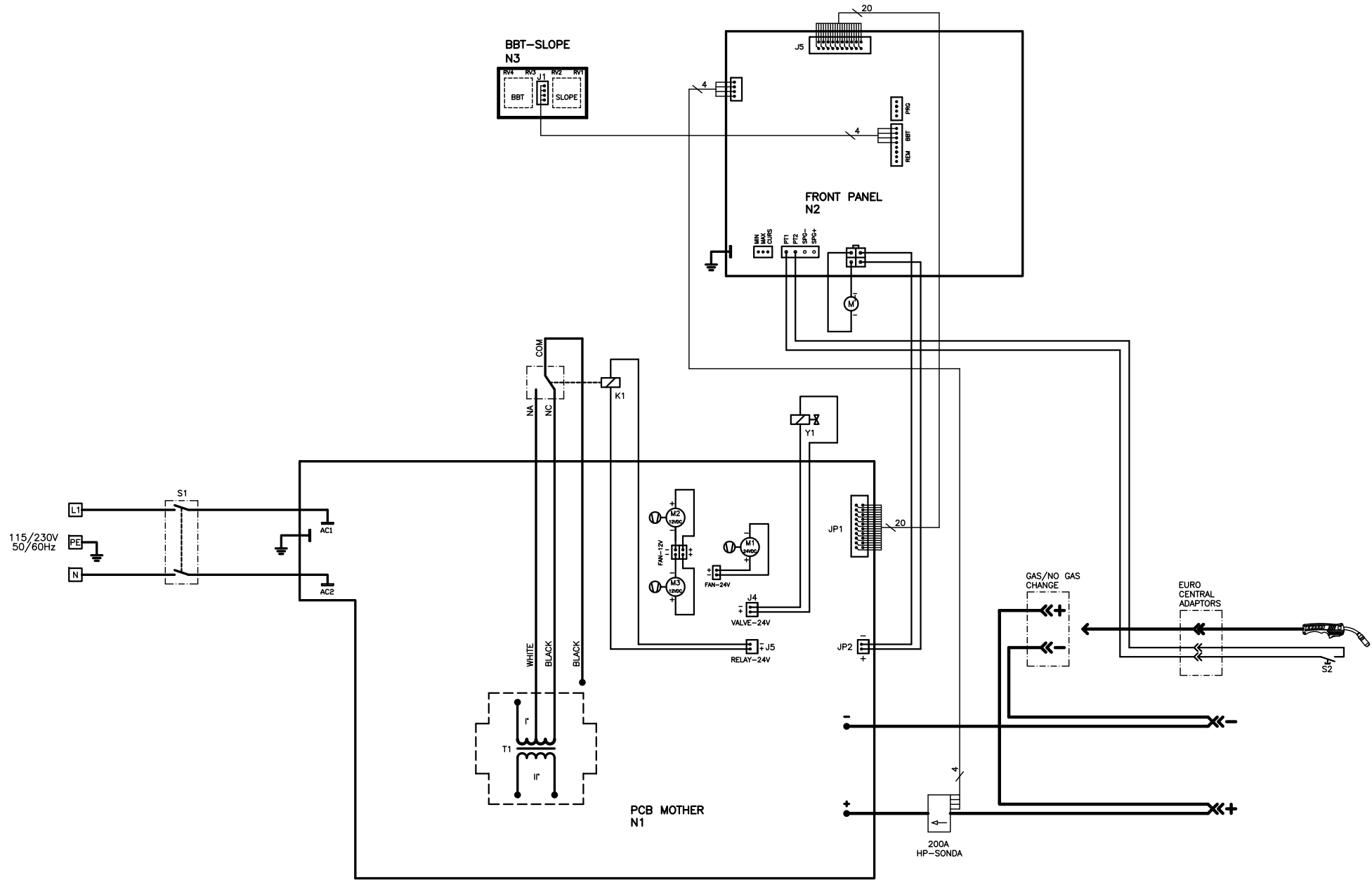

K1	RELAY	RELAIS	RELAIS	RELAIS	RELE'
Y1	SOLENOID VALVE	ELEKTROVENTIL	ELETROVANNE	ELECTROVALVULA	ELETTROVALVOLA
M	WIRE FEEDING MOTOR	DRAHTVORSCHUB MOTOR	MOTEUR D'ENTRAINEMENT DU FIL	EQUIPO ARRASSTRA HILO	MOTORE TRAINA FILO
M1-M3	FAN	VENTILATOR	VENTILATEUR	VENTILADOR	VENTILATORE
N1-N3	P.C. BOARD	ELEKTRONIK-PLATTE	FICHE ELECTRONIQUE	CIRCUITO ELECTRONICO	SCHEDA ELETTRONICA

HP	HALL PROBE	STROMSONDE	SONDE DE COURANT	SONDA HALL	SONDA DI CORRENTE
S1	ON - OFF	ON - OFF	ON - OFF	INTERRUPTOR ON - OFF	ON - OFF
S2	TORCH TRIGGER	BRENNER SCHALTER	BOUTON TORCHE	PULSADOR DE LA ANTORCHA	PULSANTE TORCIA
T1	TRANSFORMER	TRANSFORMATOR	TRANSFORMATEUR	TRANSFORMADOR	TRASFORMATORE

Denominazione
FOX 185
 Codice
S9820013